

SONY

User Guide

Personal Computer
VGX-TP1 Series



Contents

- Before Use5
 - Documentation5
- Getting Started8
 - Locating Controls and Ports9
 - About the Indicator Lights13
 - Setting Up Your Computer14
 - Shutting Down Your Computer Safely21
- Using Your VAIO Computer22
 - Using the Keyboard23
 - Using the Touch Pad31
 - Using the Optical Disc Drive32
 - Using the TV Function42
 - Using the Memory Stick Media60
 - Using Other Memory Cards66
 - Using the Internet.....69
 - Using Wireless LAN (WLAN)70

Using Peripheral Devices	78
Selecting Display Modes	79
Using the Multiple Monitors Function	80
Connecting a Universal Serial Bus (USB) Device	82
Connecting a Printer	85
Connecting an i.LINK Device	86
Connecting to a Network (LAN)	88
Customizing Your VAIO Computer	90
Setting the Password	91
Setting Up Your Computer with VAIO Central	94
Using the Power Saving Modes	95
Upgrading Your VAIO Computer	97
Adding and Removing Memory	98
Precautions	105
On Using the Power Source	106
On Handling Your Computer	107
On Handling Floppy Disks	110
On Handling Discs	111
On Using Headphones	111
On Handling Memory Stick Media	112
On Handling the Hard Disk	113

Troubleshooting	114
Computer	115
System Security	121
Networking	122
Optical Discs	125
Display	129
Printing	131
Microphone	132
Speakers	133
Keyboard	134
Touch Pad	135
Floppy Disks	136
Audio/Video	137
Memory Stick Media	138
Peripherals	139
Support Options	140
Sony Support Information	140
Program Support Information	142

Before Use

Congratulations on your purchase of this Sony VAIO® computer, and welcome to the on-screen User Guide. Sony has combined leading-edge technology in audio, video, computing, and communications to provide state-of-the-art personal computing.

! External views illustrated in this manual may look slightly different from those of your computer.

Documentation

Your documentation includes printed information and user guides to read on your VAIO computer.

Printed Documentation

- ❑ **Welcome mat** — Contains an overview of connections, setting up information, etc.
- ❑ **Safety Information** — Contains safety guidelines and owner information.

Non-printed Documentation

- ❑ **User Guide** (this manual) — Contains features of your computer. It also includes information about the software programs included with your computer, as well as information on solving common problems.
- ❑ **Specifications** — The online **Specifications** describe the hardware and software configuration of your VAIO computer.

To view the online **Specifications**:

- 1 Connect to the Internet.
- 2 Go to the Sony online support Web site at:
<http://esupport.sony.com/EN/VAIO/> for customers in USA,
<http://www.sony.ca/support> for customers in Canada,
<http://esupport.sony.com/ES/VAIO/> for customers in Spanish speaking Latin American countries or areas, or
<http://esupport.sony.com/ES/VAIO/BR/> for customers in Brazil.

- ❑ **VAIO Recovery Guide** — Provides information about restoring individual software programs, software drivers, and drive partition(s) or your entire hard disk drive to the original factory installed settings.

To access this on-screen guide:

- 1 Click **Start**  and **Help and Support**.
- 2 Click **Manuals & Specifications**.
- 3 Click **VAIO Recovery Guide**.

- ❑ **MCE Guide** (Selected models only) — Provides information about using **Windows Media Center**.

To access this on-screen guide:

- 1 Click **Start** and **Help and Support**.
- 2 Click **Manuals & Specifications**.
- 3 Click **MCE Guide**.

Help and Support

Help and Support is easy to access and provides a single location for information and technical assistance for your VAIO computer. Choose from the following categories to find the answers you need.

To access **Help and Support**, click **Start** and **Help and Support**.

Manuals & Specifications

Here you will find the on-screen **User Guide**, warranty information, other VAIO documents, and system and software information for your computer.

VAIO Support

Access interactive help in the form of VAIO tutorials, an escalation page containing support and contact information, and various links to VAIO online support Web sites.

Backup & Recovery

Find information on how to back up and restore your operating system, system software, and your personal data.

Wireless & Network

Learn about wireless connections including Bluetooth Wireless technology and Wireless LAN. Run utilities that include **VAIO Media Setup** and **Windows Network and Sharing**, and access to wireless tutorials.

Security

Keep your data safe and your computer running efficiently with updates and maintenance programs from Microsoft and Sony.

VAIO Sites

Contains links to other Internet sites you might find interesting and useful.

Getting Started

This section describes how to get started using your VAIO computer.

! Before starting your computer for the first time, do not connect any other hardware, except a display (TV), that did not originally come with your computer. Make sure to start up your computer with only the supplied accessories connected and set up your system. Upon completion, connect one device (for example, a printer, an external hard disk drive, a scanner, and so on) at a time, following the manufacturers' instructions.

- ❑ **Locating Controls and Ports** ([page 9](#))
- ❑ **About the Indicator Lights** ([page 13](#))
- ❑ **Setting Up Your Computer** ([page 14](#))
- ❑ **Shutting Down Your Computer Safely** ([page 21](#))

Locating Controls and Ports

Take a moment to identify the controls and ports shown on the following pages.

Top

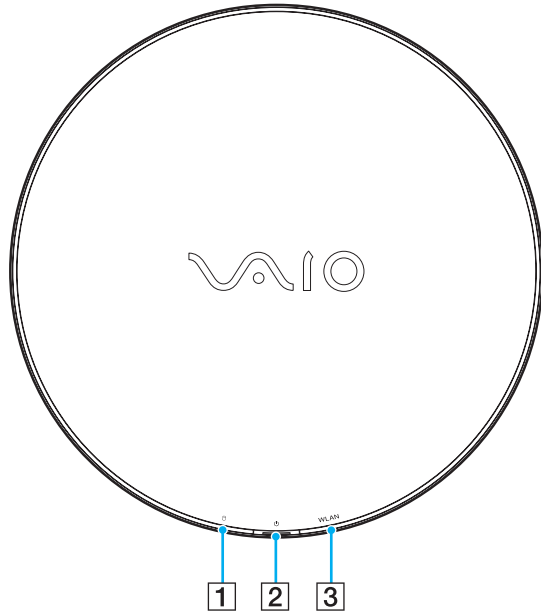

- 1 Hard disk drive/Optical disc drive indicator ([page 13](#))
- 2 Power button/Power indicator ([page 13](#))
- 3 **WLAN** (Wireless LAN) indicator ([page 13](#))

Front

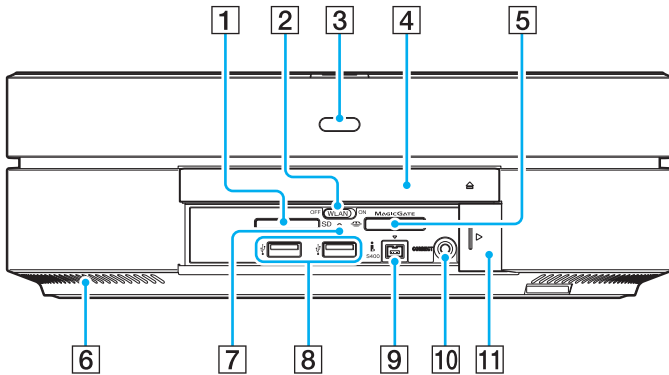

- 1 **SD** memory card slot ([page 66](#))
- 2 **WLAN** (Wireless LAN) switch ([page 70](#))
- 3 Infrared receiver/Infrared signal indicator ([page 13](#))
Point the supplied remote commander to this sensor for operations.
- 4 Optical disc drive ([page 32](#))
- 5 Memory Stick PRO/Duo media slot^{*1} ([page 60](#))
- 6 Air vent
- 7 Media Access indicator ([page 13](#))
- 8 Hi-Speed USB (USB 2.0) ports^{*2} ([page 82](#))
- 9 i.LINK (IEEE 1394) S400 port ([page 86](#))
- 10 **CONNECT** button ([page 27](#))
- 11 Front panel door
To open the front panel door, put your fingertip on the left end of the door and slide it half way to the right. The door will automatically be retracted under the panel. To close the door, slide it half way to the left. The door will keep sliding on its own and shut.

^{*1} Your computer supports Memory Stick Duo media and Memory Stick PRO media with high speed and high capacity capabilities.

^{*2} Supports high-/full-/low- speeds.

Back

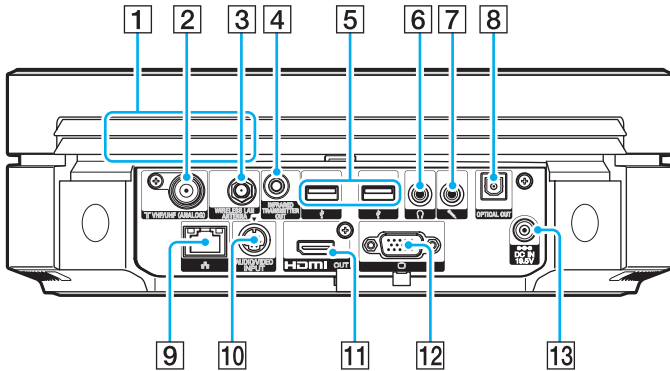

- 1 Air vent
- 2 **VHF/UHF (ANALOG)** port (page 43)
- 3 **WIRELESS LAN ANTENNA** port (page 72)
- 4 **INFRARED TRANSMITTER OUT** jack (page 58)
- 5 Hi-Speed USB (USB 2.0) ports* (page 82)
- 6 Headphones jack
Connect external headphones.
- 7 Microphone jack
Connect an external microphone.
- 8 **OPTICAL OUT** port
Connect a digital device, such as an AV amplifier.
- 9 Network (Ethernet) port (page 88)
- 10 **AUDIO/VIDEO INPUT** port (page 50)
- 11 **HDMI OUT** port (page 15)
- 12 Monitor (VGA) port (page 17)
- 13 **DC IN** port (page 18)

* Supports high-/full-/low- speeds.

! The area around the air vent (1) becomes hot while your computer is on. Be sure to wait until the computer cools down before you touch it.

HDMI, the HDMI logo and High-Definition Multimedia Interface are trademarks or registered trademarks of HDMI Licensing LLC.

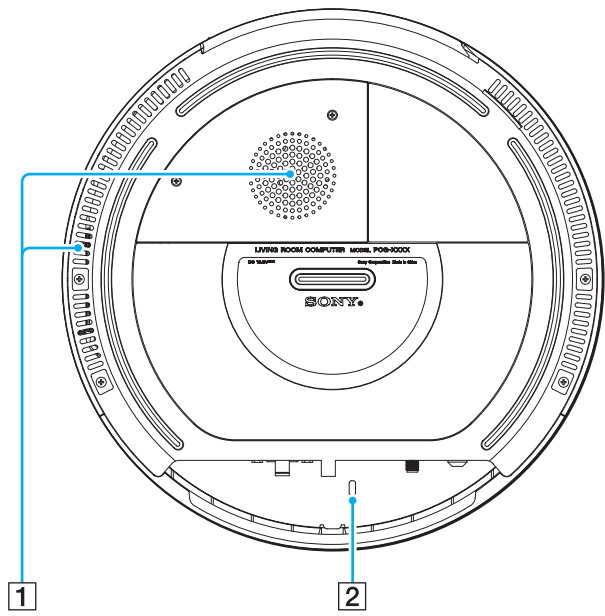

Bottom



- 1 Air vents
- 2 Security slot

About the Indicator Lights

Your computer is equipped with the following indicator lights.

Indicator	Functions
Power 	The indication behavior varies depending on the state of your computer: Green lit: the computer is on. Orange lit: the computer is in Sleep mode. Off: the computer is off.
Media Access	Illuminates when data is read from or written to a memory card. (Do not enter Sleep mode or turn off the computer when this indicator is on.) When the indicator is off, the memory card is not being used.
Hard disk drive/Optical disc drive 	Illuminates when data is read from or written to the hard disk or the optical disc. Do not enter Sleep mode or turn off the computer when this indicator is on.
Wireless LAN	Illuminates when the wireless LAN function is running.
Infrared signal	Illuminates upon reception of infrared signals from the remote commander.

Setting Up Your Computer

Connecting a Display

Connect a display (not supplied) to your computer. When connecting it, see the manual that came with your display as well.

To connect a display (HDMI-compatible TV)



If your TV is equipped with a DVI-D port, you can use the HDMI cable and the HDMI to DVI-D adapter (both supplied) for connection. To use them for connection, however, you also need an audio cable (not supplied) since no audio signals are carried through the DVI-D port.

- 1 Plug one end of the HDMI cable (supplied) (1) to the **HDMI OUT** port (2) on the computer.
- 2 Plug the other end to the display (TV) (3).

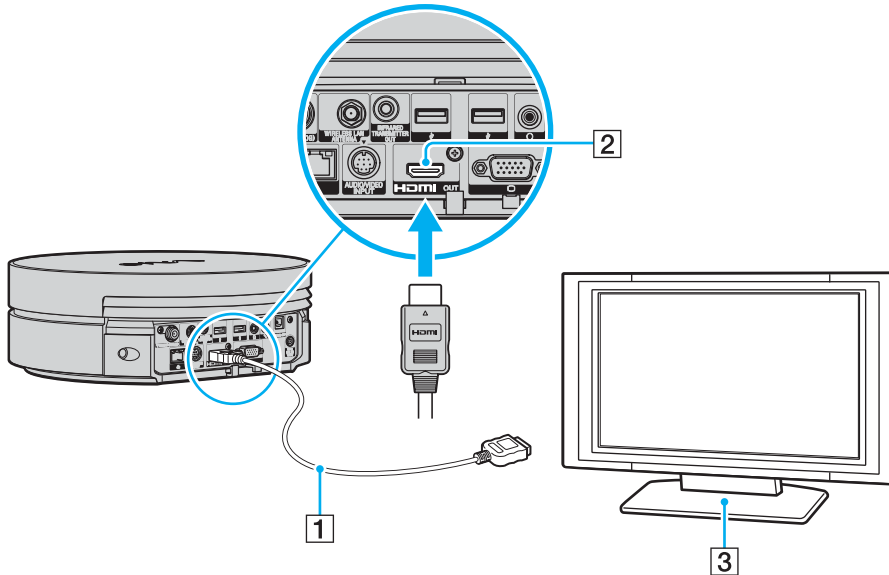

! If your TV is equipped with an HDMI port and a DVI-D port, we recommend that you use the HDMI port.

The HDMI cable carries both video and audio signals.

If a device driver other than the one provided by Sony is used, the image will not be displayed and the audio will not be heard. Always use the device driver provided by Sony for updates.

Your computer is compliant with the HDCP standard and capable of encrypting the transmission channel of digital video signals for the purpose of copyright protection, which enables you to play and view a wide variety of copyright protected, high-quality contents. Note that you need to connect an HDCP-compliant external display to your computer to view the copyright protected contents. If your computer has a non-compliant display connected, you will not be able to play or view any copyright protected contents, including Blu-ray movie contents.

To change the sound output device

If you do not hear sound from the device connected to the HDMI port, you need to change the device for sound output.

- 1 Close all open programs.
- 2 Click **Start** and **Control Panel**.
- 3 Click **Hardware and Sound**.
- 4 Click **Manage audio devices** under **Sound**.
- 5 On the **Playback** tab, select the desired device for sound output and click **Set Default**.

To connect a display (monitor)

- 1 If you want to connect a VGA monitor, connect the display cable (1) (not supplied) into the monitor (VGA) port (2) on the back of the computer.
- 2 If necessary, plug the display cable into the display.

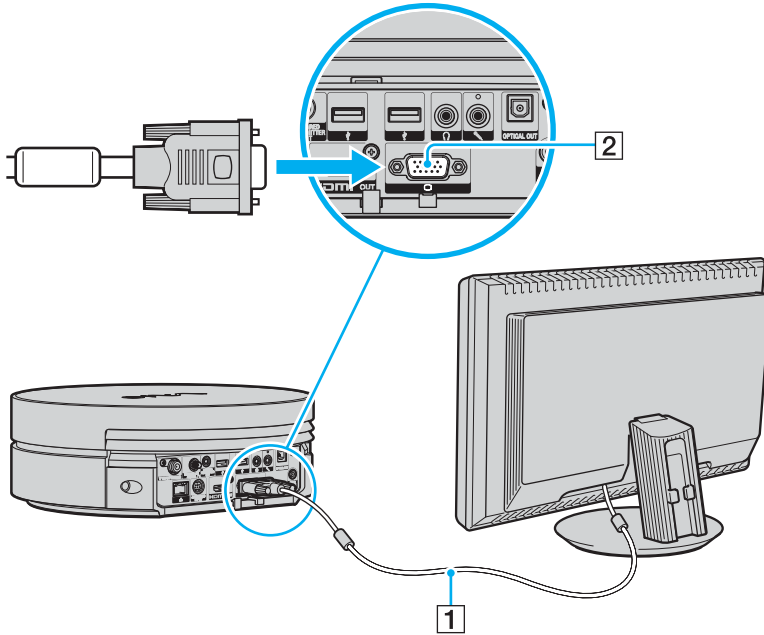

Connecting a Power Source

You need an AC adapter to connect to an AC power source and it must be plugged into the power source before you can establish communication with your wireless keyboard.



Use your computer only with the supplied AC adapter.

To connect the AC adapter

- 1 Plug one end of the power cord (1) into the AC adapter (3).
- 2 Plug the other end of the power cord and the power cord from your display (TV) into AC outlets (2).
- 3 Route the cable from the AC adapter (3) through the hooks (4) on the back of your computer and plug it into the **DC IN** port (5).

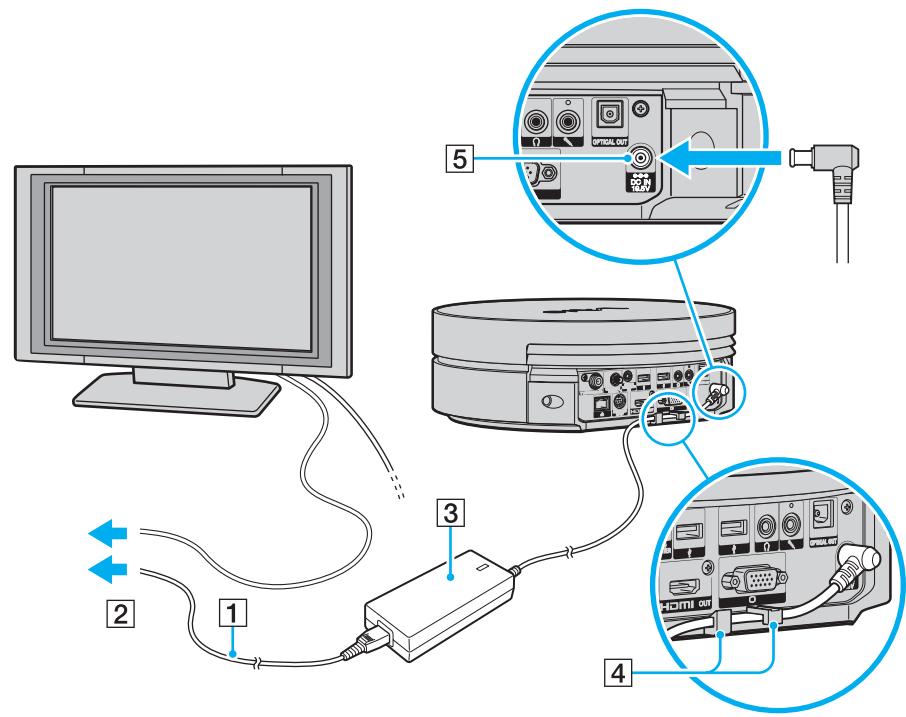

 To disconnect your computer completely from AC power, unplug the power cord.

Make sure that the AC outlets are easily accessible.

Attaching the Rear Cover

An exclusively designed rear cover is supplied with your computer for port protection and tidy cabling. Once you have set up your computer, attach the rear cover. Be sure to hold the cover with your both hands when attaching it.

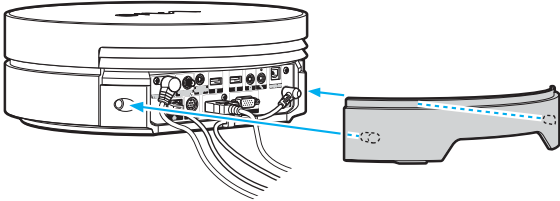

! You may not be able to attach the rear cover depending on the shape or size of connected cable plugs. In such a case, leave the rear of your computer uncovered and keep the rear cover at hand.

To remove the rear cover, grasp the cover as illustrated below and pull it away from the computer.

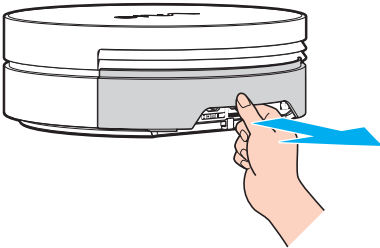

! Do not leave the removed rear cover on the floor. Stepping on it may hurt your foot.

Shutting Down Your Computer Safely

To avoid losing unsaved data, be sure to shut down your computer properly, as described below.

To shut down your computer

- 1 Turn off any peripherals connected to the computer.
- 2 Click **Start**, the arrow  next to the **Lock** button, and **Shut Down**.
- 3 Respond to any prompts warning you to save documents or to consider other users and wait for the computer to turn off automatically.
The power indicator light turns off.

Using Your VAIO Computer

This section describes how to get the most out of using your VAIO computer.

- ❑ **Using the Keyboard** ([page 23](#))
- ❑ **Using the Touch Pad** ([page 31](#))
- ❑ **Using the Optical Disc Drive** ([page 32](#))
- ❑ **Using the TV Function** ([page 42](#))
- ❑ **Using the Memory Stick Media** ([page 60](#))
- ❑ **Using Other Memory Cards** ([page 66](#))
- ❑ **Using the Internet** ([page 69](#))
- ❑ **Using Wireless LAN (WLAN)** ([page 70](#))

Using the Keyboard

A wireless keyboard is supplied with your computer.

The wireless keyboard uses a standard key arrangement with additional keys that perform specific functions.

Using the Wireless Keyboard

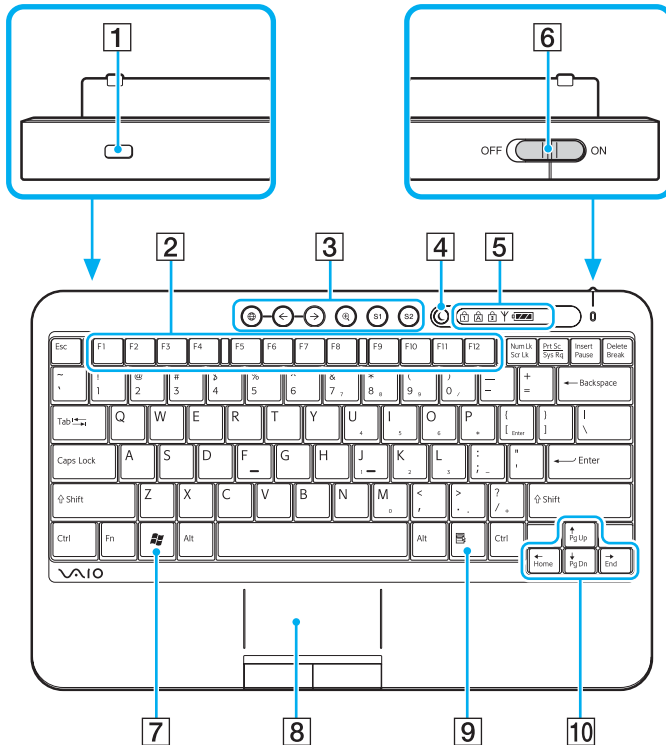



- 1 Security slot
- 2 Function keys
Perform certain tasks. The task associated with each function key varies among software applications.
- 3 Shortcut buttons
Perform the pre-assigned tasks. The default tasks are as follows:
 - 🌐: Launches **VAIO Living Browser**.
 - ←, →: Displays the previous or next page while **VAIO Living Browser** is running.
 - ⊕: Magnifies the screen view while **VAIO Living Browser** is running. One press magnifies the contents by 25%. When magnification reaches 175%, it goes back to 100%.
 - S1: Opens the **Media Center Start** menu.
 - S2: Launches **Resolution Setting Utility**.
- 4 Standby button
Provides for the lower level of power consumption. For details on power management, see **Using the Power Saving Modes** (page 95).



5 Indicators

 (Num lock): Turns on while in the Num Lock state.

 (Caps lock): Turns on while in the Caps Lock state.

 (Scroll lock): Turns on while in the Scroll Lock state.

 (Connect): Turns on while connection between the computer and the wireless keyboard is in place to indicate that the keyboard is ready for use ([page 28](#)).

 (Battery):  turns on while the AA batteries for the wireless keyboard are sufficient and switches to  when the batteries wear out.

6 Power switch

Slide the power switch to turn on and off the wireless keyboard.

7 Windows key

Displays the **Start** menu.

8 Touch pad

See **Using the Touch Pad (page 31)** for more information.

9 Applications key

Displays a shortcut menu in certain software applications.

10 Directional arrow keys

Move the pointer on the screen.

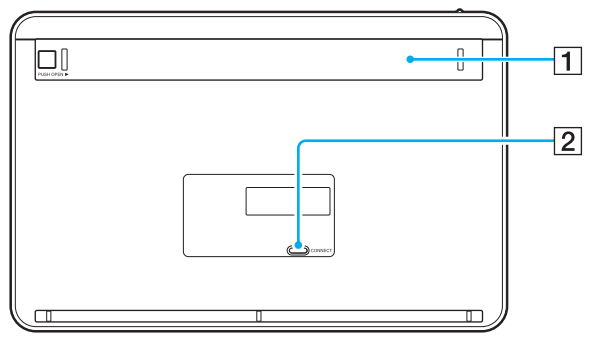

- 1 Battery compartment
Storage compartment for the AA batteries.
- 2 **CONNECT** button [\(page 27\)](#)
Press to enable the wireless keyboard to communicate with the computer.

Before you use the keyboard

Four AA alkaline batteries are supplied with your computer for use in the wireless keyboard. Before attempting to use the wireless keyboard, you must install the batteries and establish communication between the computer and the keyboard.



To maintain good communication, operate the wireless keyboard within the distance limitations of keyboard: approximately 32.8 feet (10 m) from your computer.

Confirm that the supplied AA batteries are properly installed.

Press the **CONNECT** button located on the front of your computer first, and then press the **CONNECT** button on the bottom of the wireless keyboard.

Avoid using any wireless devices that exchange radio signals on the 2.4 GHz frequency band near the wireless keyboard. These devices may cause interference, causing the keyboard to stop working properly.

Do not place metal furniture near your computer or wireless keyboard, as this may create interference, causing the keyboard to stop working properly.

Do not mix old (used) and new batteries when replacing batteries in the wireless keyboard. Always use the same type and manufacture of battery.

Do not mix alkaline with manganese batteries. Using incompatible batteries or mixing used, new or different types of batteries can damage the wireless keyboard.

To connect the wireless keyboard

! To connect your wireless keyboard, it must be located within a range of approximately 11 inches (30 cm) to 40 inches (1 m) from the computer.

- 1 Turn over the wireless keyboard.
- 2 Press the button (1) on the battery compartment cover and slide and lift the cover in the direction of the arrow to remove the cover.

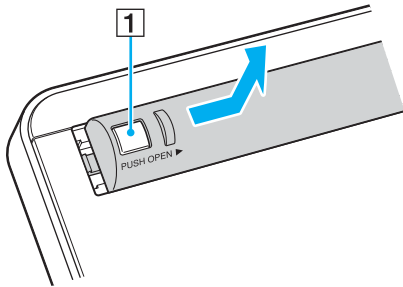

- 3 Insert the supplied four AA batteries into the battery compartment as illustrated below:

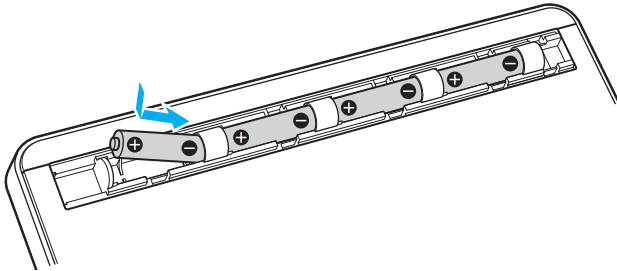

- 4 Turn on the computer.
- 5 Slide the power switch (2) on the keyboard to the **ON** position.
- 6 Press the **CONNECT** button (3) on the front of the computer.
- 7 Press the **CONNECT** button (4) on the bottom of the keyboard.

The connect indicator Υ turns on in the indicator window on the keyboard when connection is established between the computer and the keyboard. If not, repeat the procedure.



Steps 6 and 7 must be completed within 10 seconds of each other.

If the wireless keyboard is left unused for 20 minutes or longer, the connect indicator Υ will turn off. This could indicate that the connection between your computer and the keyboard is lost. Press the **Fn** key to check that the connect indicator turns on before using the keyboard.

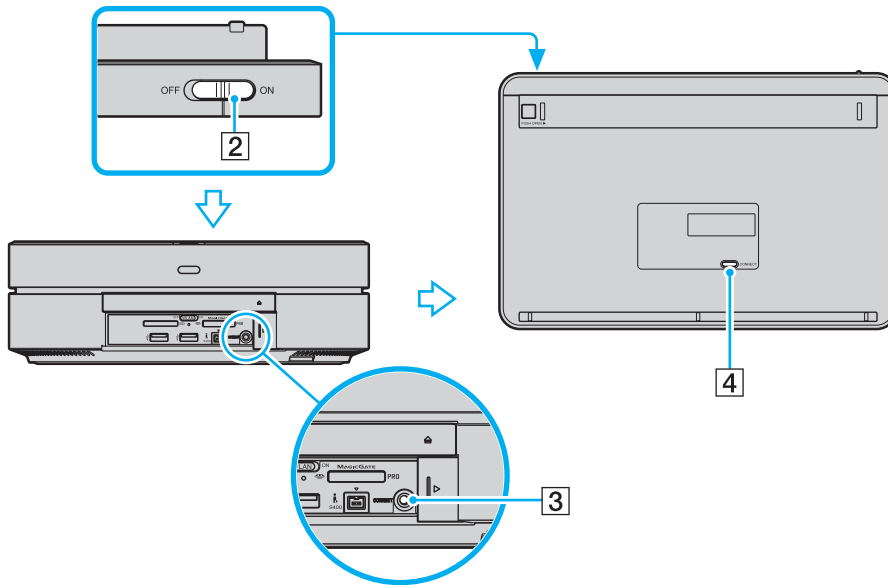

You can check the battery indicator ( or ) in the LCD window on the wireless keyboard for its battery power level.

If the wireless keyboard does not operate properly, the batteries may need to be replaced. If the wireless keyboard is not being used for an extended period of time, remove the batteries to avoid possible damage from battery leakage.

Using the Touch Pad

You can point to, select, drag, and scroll objects on the screen using the touch pad.

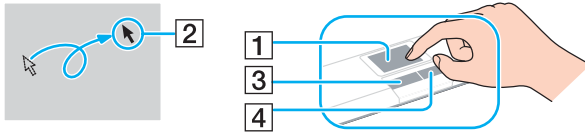

Action	Description
Point	Slide your finger on the touch pad (1) to place the pointer (2) on an item or object.
Click	Press the left button (3) once.
Double-click	Press the left button twice.
Right-click	Press the right button (4) once. In many applications, this action displays a shortcut menu.
Drag	Slide your finger on the touch pad while pressing the left button.
Scroll	Slide your finger along the right edge of the touch pad to scroll vertically. Slide your finger along the bottom to scroll horizontally (the scroll function is available only with applications that support a touch pad scroll feature).



To keep moving the pointer or scrolling, slide and hold your finger at the edge of the touch pad.



If pointer movement or scrolling continues against your intention, your fingertip may have reached an edge of the touch pad. In such a case, take your finger off the touch pad. It is recommended that you put your finger on the touch pad around its center to start an operation.

Using the Optical Disc Drive

Your computer is equipped with an optical disc drive.

To insert a disc

- 1 Turn on the computer.
- 2 Push in the optical disc drive tray with your fingertip to eject it.
- 3 Grasp the tray and gently pull it out.

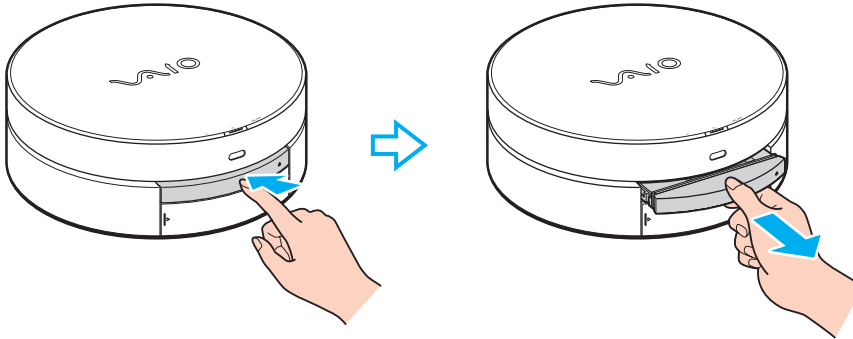

- 4 Place a disc in the middle of the tray with the label side facing upward; and gently push it until the disc clicks into place while holding the bottom of the tray with the other hand.

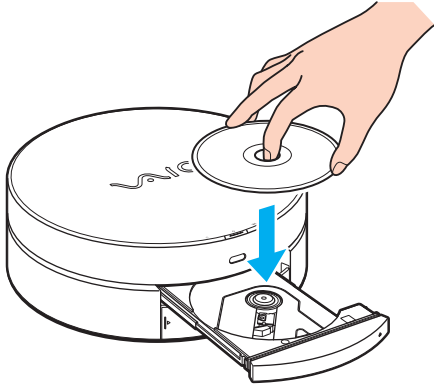

! When the optical disc drive tray is out, be sure not to exert pressure on the tray as it may damage the tray or the disc drive.

- 5 Close the tray by pushing it in gently.

! Do not remove the optical disc when your computer is in Sleep mode. Doing so may cause the computer to malfunction.

Before removing the optical disc, make sure that the optical disc drive indicator light is off.

Reading and Writing Optical Discs

Your computer plays and records CDs, DVDs, or Blu-ray Discs, depending on the model you purchased. Check your specifications for the type of optical disc drive installed on your model. Use the table below to see which types of media your optical disc drive supports.

PR: playable and recordable
 P: playable but not recordable
 -: not playable or recordable

	CD-ROM	Video CD	Music CD	CD Extra	CD-R/RW	DVD-ROM	DVD-Video	DVD-R/RW	DVD+R/RW	DVD+R DL	DVD-R DL	DVD-RAM
DVD±RW/±R DL/RAM	P	P	P	P	PR	P	P	PR ^{*1 *2}	PR	PR ^{*5}	PR ^{*6}	PR ^{*3 *4}
DVD±RW (Supporting DVD±R DL)	P	P	P	P	PR	P	P	PR ^{*1 *2}	PR	PR ^{*5}	PR ^{*6}	-
CD-RW/DVD-ROM	P	P	P	P	PR	P	P	P	P	P	P	-
DVD-ROM	P	P	P	P	P	P	P	P	P	P	P	-

^{*1} Supports writing data to DVD-R discs compliant with DVD-R for General Version 2.0/2.1.

^{*2} Supports writing data to DVD-RW discs compliant with DVD-RW Version 1.1/1.2.

^{*3} The DVD±RW/RAM disc drive on your computer does not support the DVD-RAM cartridge. Use non-cartridge discs or discs with removable cartridge.

^{*4} Writing data to single-sided DVD-RAM discs (2.6 GB) compliant with DVD-RAM Version 1.0 is not supported.
 DVD-RAM Version 2.2/12X-SPEED DVD-RAM Revision 5.0 disc is not supported.

^{*5} Writing data to DVD+R DL (Double Layer) discs is available only on discs supporting DVD+R DL (Double Layer) recording.

^{*6} Writing data to DVD-R DL (Dual Layer) discs is available only on discs supporting DVD-R DL (Dual Layer) recording.

PR: playable and recordable
 P: playable but not recordable
 -: not playable or recordable

	CD-ROM	Video CD	Music CD	CD Extra	CD-R/RW	DVD-ROM	DVD-Video	BD-ROM	DVD-R/RW	DVD+R/RW	DVD+R/DL	DVD-R/DL	DVD-RAM	BD-R ^{*9} /RE ^{*10}
Blu-ray Disc Drive	P	P	P	P	PR ^{*8}	P	P	P	PR ^{*1} ^{*2}	PR	PR ^{*5}	PR ^{*6}	PR ^{*3} ^{*4}	PR ^{*7}

^{*7} Supports writing data to BD-R Version 1.1 discs (single-layer discs with the capacity of 25 GB, dual-layer discs with the capacity of 50 GB) and BD-RE Version 2.1 discs (single-layer discs with the capacity of 25 GB, dual-layer discs with the capacity of 50 GB). The Blu-ray Disc drive on your computer does not support BD-RE Version 1.0 discs and Blu-ray cartridge discs.

^{*8} Writing data to Ultra Speed CD-RW discs is not supported on models with the Blu-ray Disc drive.

^{*9} BD-R stands for Blu-ray Disc-Recordable in Version 1.1 format.

^{*10} BD-RE stands for Blu-ray Disc-Rewritable in Version 2.1 format.

!
 This product is designed to playback discs that conform to the Compact Disc Digital Audio standard specifications (CD Standard). A DualDisc is a two sided disc product which mates DVD recorded material on one side with digital audio material on the other side. Be aware that the audio side (non-DVD side) of a DualDisc may not play on this product because it does not conform to the CD Standard.

Due to the multiple formats of discs now available, when buying pre-recorded or blank discs for use with a VAIO computer, be sure to read the notices on the disc packaging carefully to check both playback and recording compatibility with your computer's optical disc drives. Sony does NOT guarantee the compatibility of VAIO CD drives with discs that are not compliant with the official "CD" format standard (or "DVD" standard in relation to DVD drives). USING NON-COMPLIANT DISCS CAN CAUSE FATAL DAMAGE TO YOUR VAIO PC OR CREATE SOFTWARE CONFLICTS AND CAUSE SYSTEM HANGING. For inquiries about disc formats, contact the individual publisher of the pre-recorded disc or the manufacturer of the recordable disc.



8cm disc writing is not supported.

! To play copyright protected Blu-ray Discs continually, you need to update the AACS key. Note that the AACS key update requires Internet access.

As with other optical media devices, circumstances may limit compatibility or prevent Blu-ray Disc playback. VAIO computers may not support movie playback on packaged media recorded in AVC or VC1 formats at high bit rates.

Region settings are required for Movies and BD-ROM contents. If the region setting and the region of the disc do not match, playback is not possible.

Unless your external display is compliant with the High-bandwidth Digital Content Protection (HDCP) standard, you cannot play or view the contents of copyright protected Blu-ray Discs.

Some contents may restrict video output to be standard definition or prohibit analog video output at all. It is strongly recommended that digital HDCP-compliant environment be implemented for optimum compatibility and viewing quality.

Notes on writing data to a disc

- ❑ Use only Sony Value-added software to write data to a disc. (e.g. **Click to DVD**)
Other software programs may not be fully compatible and errors may result.
- ❑ To make data on a disc readable on the optical disc drive, you need to close the session before you eject it. To complete this process, follow the instructions included with your software.
- ❑ Only use circular discs. Do not use discs in any other shape (star, heart, card, etc.), as this may damage the optical disc drive.
- ❑ Do not strike or shake your computer while writing data to a disc.
- ❑ Deactivate the screen saver and exit anti-virus software before writing data to a disc.
- ❑ Do not use memory-resident utility software while writing data to a disc. This may cause your computer to malfunction.
- ❑ When using your software application to burn discs, make sure you exit and close all other applications.
- ❑ Never touch the surface of the disc. Fingerprints and dust on the surface of a disc may cause writing errors.
- ❑ Do not switch power modes while using the preinstalled software or any disc burning software.
- ❑ Never affix an adhesive label to a disc. This will affect the use of the disc irreparably.
- ❑ Make sure you use the same disc burning software to add data to a used disc. Use of different disc burning software for additional data burning may cause a failure. For example, if you have a disc with data that you burned with the **Roxio Easy Media Creator** software, use the **Roxio Easy Media Creator** software to add some data to the same disc.

Notes on playing discs

To achieve optimum performance when playing DVDs, you should follow these recommendations.

- Close all open applications before playing a DVD movie.
- Some CD players and computer's optical disc drives may not be able to play audio CDs created with the CD-R or CD-RW disc media.
- Some DVD players and computer's optical disc drives may not be able to play DVDs created with the DVD+R DL, DVD-R DL, DVD+R, DVD+RW, DVD-R, DVD-RW, or DVD-RAM disc media.
- Do not use memory-resident utility software to speed up disc access when playing a DVD. This may cause your computer to malfunction.
- Deactivate the screen saver and exit anti-virus software before playing a disc.
- Some discs recorded at 20 or 24 bits may produce noise while playing. If you have audio devices connected, this may damage your hearing and the speakers. Reduce the volume before playing a DVD.
- Do not switch to power saving modes while your computer is playing a DVD.
- Region code indicators are labeled on the DVDs to indicate in which region and on what type of player you can play the disc. If the DVD is labeled "all," this means that you can play this DVD in most regions of the world. If the region code of your residence area is different from the label on the DVD disc or on the packaging, you cannot play the disc on your computer.



You can change the DVD region code only a limited number of times. When you have exceeded this number, the drive's DVD region code is permanently assigned and you will not be able to change it again. Reconfiguring your computer does not reset this count.

If you change the DVD region code while the **WinDVD** or **WinDVD BD** software is running, restart the software or eject the disc and re-insert it to make the new setting effective.

- ❑ When you are playing a DVD (video or audio) and you want to remove a USB device, such as USB-compatible speakers, make sure you stop the DVD first. Removing a USB-compatible device during DVD (video or audio) playback may cause a malfunction.

Playing CDs

To play an audio CD

- 1 Insert a disc into the optical disc drive.
- 2 If nothing appears on the desktop, then click **Start, All Programs**, and the desired CD software to play the CD.
If the **Audio CD** window appears, click to select an option.

Copying Files to CDs

To copy files to a disc

! Do not strike or shake your computer while writing data to a disc.

- 1 Insert a disc into the optical disc drive.
If the **AutoPlay** window appears, click **Burn files to disc** and follow the on-screen instructions until the empty disc folder appears.
- 2 Open the folder that contains the file(s) you want to copy and drag them to the empty disc folder.
- 3 Close the disc folder.

Playing DVDs

To play a DVD

- 1 Close all running software applications.
- 2 Insert a DVD into the optical disc drive.
- 3 If nothing appears on the desktop, then click **Start, All Programs**, and the desired DVD software to play the DVD.

For instructions on how to use the software, see the help file on your DVD software.

Copying Files to DVDs

To copy files to a disc

- 1 Insert a disc into the optical disc drive.
- 2 If nothing appears on the desktop, then click **Start, All Programs**, and the desired DVD software to copy files to the disc.

For instructions on how to use the software, see the help file on your DVD software.

Using the TV Function

Your computer has an analog TV tuner board installed along with **Windows Media Center** to enhance your audio and visual experience.

Media Center provides you with a wide range of TV, DVD, and video viewing, as well as music recording and playback. This section describes how to set up your TV, set-top box, and other equipment. See the on-screen **MCE Guide** for more information on Media Center features.

To access this on-screen guide

- 1 Click **Start** and **Help and Support**.
- 2 Click **Manuals & Specifications**.
- 3 Click **MCE Guide**.

Setting Up TV Connections



The following connections may not be available depending on the country or area of your residency.

The best method of connecting your computer system, TV monitor or display, and cable service access, depends on the type of cable connection available in your home.

TV signal reception strength will vary widely depending on service availability in your area as well as the type of connection available.

One primary cable to connect the computer to a TV cable or antenna is the TV coaxial cable (supplied). One end connects to the computer's **VHF/UHF (ANALOG)** port, and the other end connects to the cable service access or antenna.



1 TV coaxial cable

Connecting to standard cable access (CATV)

To connect in CATV mode (Option 1)

- 1 Connect one end of the TV coaxial cable (1) (supplied) to your cable service access (wall outlet) (2).
- 2 Connect the other end to the **VHF/UHF (ANALOG)** port (3) on the computer.

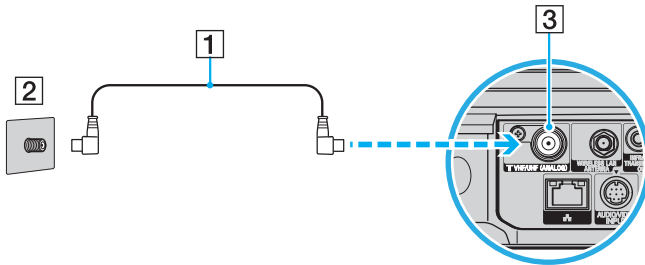

To connect in CATV mode (Option 2)

- 1 Connect the two metal hooks on a 75-ohm/300-ohm RCA transformer cable (1) (not supplied) to the screw-type grips at your cable service access (wall outlet) (2).
- 2 Connect one end of the TV coaxial cable (3) (supplied) to the transformer end of the RCA transformer cable (1). Connect the other end to the **VHF/UHF (ANALOG)** port (4) on the computer.

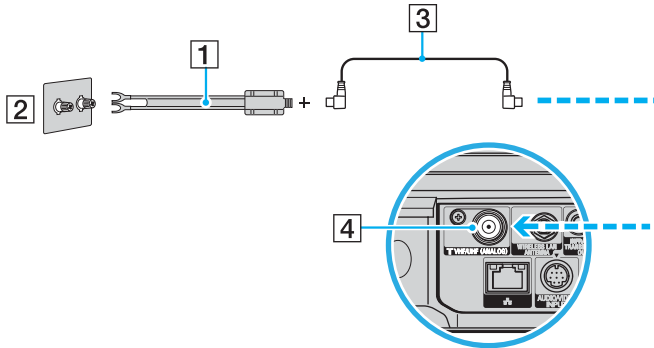

Connecting to a standard antenna

You can connect your computer to an indoor/outdoor antenna system, using Option 1 or Option 2 from the previous section, **Connecting to standard cable access (CATV)** (page 44). Depending on the type of antenna system in your home, your connection may require a VHF/UHF RF combiner/transformer (not supplied) to connect the computer and the indoor/outdoor antenna system.



If you are connecting to an indoor/outdoor antenna, you may need to reorient the antenna for best reception. Move the antenna cable away from other power sources or connectors to reduce reception interference.

To connect in terrestrial mode (Option 1)

- 1 Connect one end of a TV coaxial cable (1) (not supplied) to your antenna outlet (2). Connect the other end to a VHF/UHF RF combiner/transformer (3) (not supplied).
- 2 Connect a coaxial cable feed connector (4) (not supplied) to the VHF/UHF RF combiner/transformer (3).
- 3 Connect one end of another TV coaxial cable (5) (supplied) to the feed connector (4). Connect the other end to the **VHF/UHF (ANALOG)** port (6) on the computer.

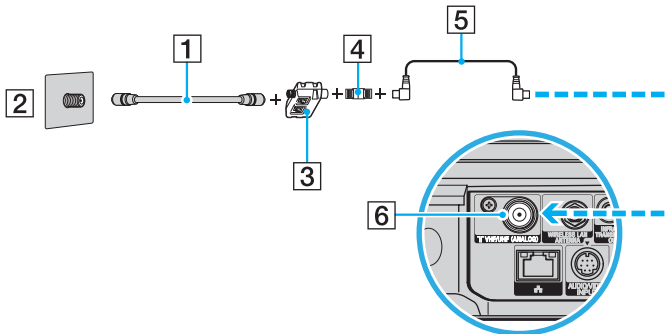

To connect in terrestrial mode (Option 2)

- 1 Connect one end of a 300-ohm twin lead cable (1) (not supplied) to the screw-type grips at your antenna outlet (2). Connect the other end to the grips on a VHF/UHF RF combiner/transformer (3) (not supplied).
- 2 Connect a coaxial cable feed connector (4) (not supplied) to the VHF/UHF RF combiner/transformer (3).
- 3 Connect one end of the TV coaxial cable (5) (supplied) to the feed connector (4). Connect the other end to the **VHF/UHF (ANALOG)** port (6) on the computer.

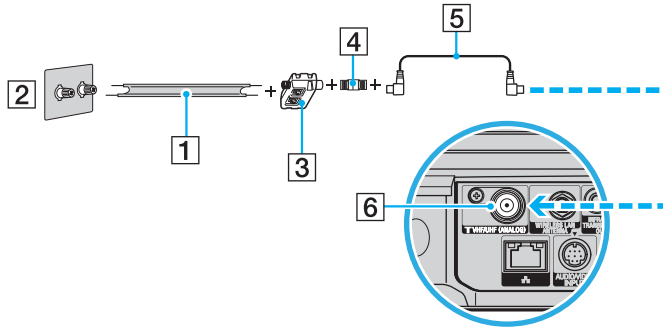

Connecting with a cable or satellite set-top box (STB)

You can connect your computer to cable service access that uses a set-top box (cable or satellite). When using the set-top box (STB) setup, you can only change channels through the STB, using its controls or the supplied remote commander.

When using the STB setup:

- ❑ A standard TV remote control cannot be used to change TV channels. You can use your TV remote control to set the TV to the channel-out number (channel 3, 4, etc.) or direct video input specified by your cable or satellite service provider.
- ❑ You may be able to use a universal remote control or commander to change TV channels, if the device is capable of controlling the STB.

To connect in STB mode (Option 1)

- 1 Connect one end of a TV coaxial cable (1) (not supplied) to your cable service access (wall outlet) (2). Connect the other end to the VHF/UHF IN port on the back panel of your set-top box (STB) (3).
- 2 Connect a second TV coaxial cable (4) (not supplied) to the VHF/UHF OUT port on the set-top box (STB) (3). Connect the other end to the single-connection end of a splitter device (5) (not supplied).
- 3 Connect a third TV coaxial cable (6) (supplied) to the double-connection end of the splitter device (5). Connect the other end to the **VHF/UHF (ANALOG)** port (7) on the computer.
- 4 Connect a fourth TV coaxial cable (8) (not supplied) to the double-connection end of the splitter device (5). Connect the other end to the VHF/UHF port (9) on the rear of your TV monitor or display.

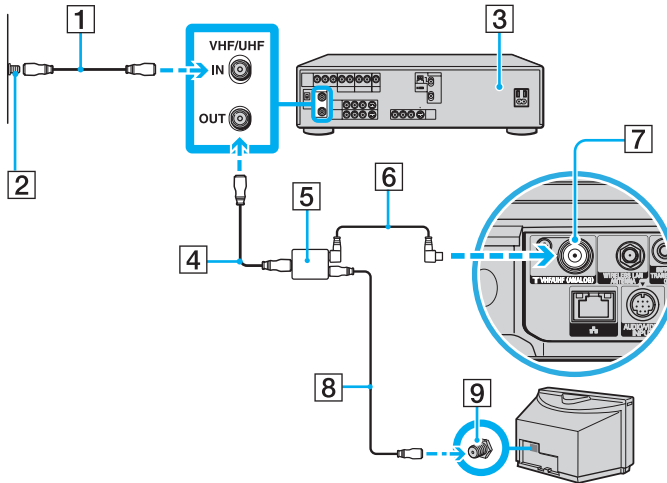

To connect in STB mode (Option 2)

- 1 Connect one end of a TV coaxial cable (1) (not supplied) to your cable service access (wall outlet) (2). Connect the other end to the VHF/UHF IN port on the back panel of your set-top box (STB) (3).
- 2 Connect a second TV coaxial cable (4) (not supplied) to the VHF/UHF OUT port on the set-top box (STB) (3). Connect the other end to the VHF/UHF port (5) on the rear of your TV monitor or display.
- 3 Connect one end of a stereo A/V dubbing cable with triple RCA plugs (6) (not supplied), to the Composite Audio Out (L/R) jacks (7) and the Video Out jack (8) on the back panel of your set-top box (STB) unit (3), matching the plug and jack colors.
- 4 Connect the other RCA plugs of the stereo A/V dubbing cable (6) to the appropriate plug receptacles of the AV cable adapter (9) (supplied), matching the plug and receptacle colors.
- 5 Connect the other end of the AV cable adapter (9) into the **AUDIO/VIDEO INPUT** port (10) on the computer.
- 6 If you prefer better video quality, connect one end of an S Video cable (11) (not supplied) to the S Video Out port (12) on the back panel of the set-top box (STB) (3). Connect the other end to the S Video plug receptacle of the AV cable adapter (9).

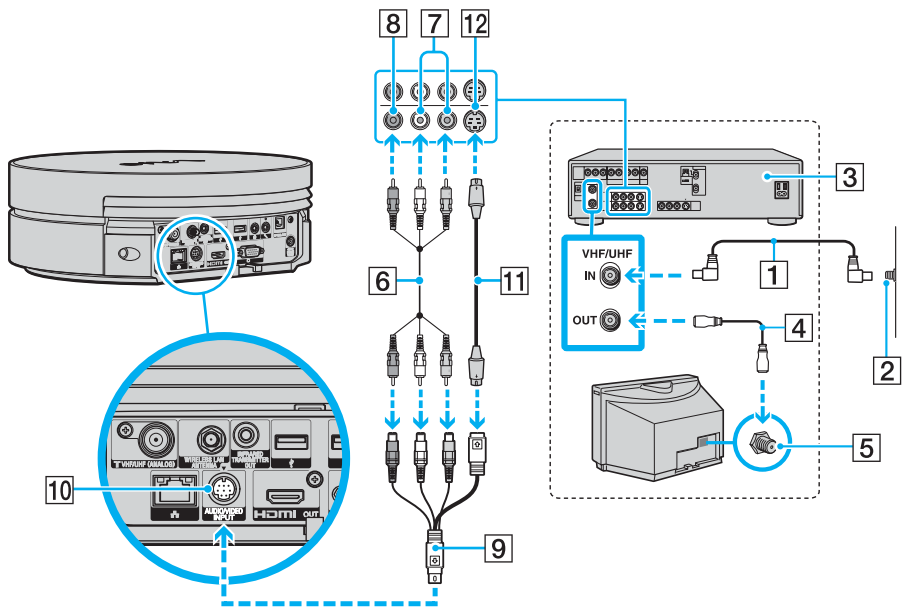

Using the Remote Commander

A remote commander is supplied with your computer for using Media Center features, including TV channel selection.

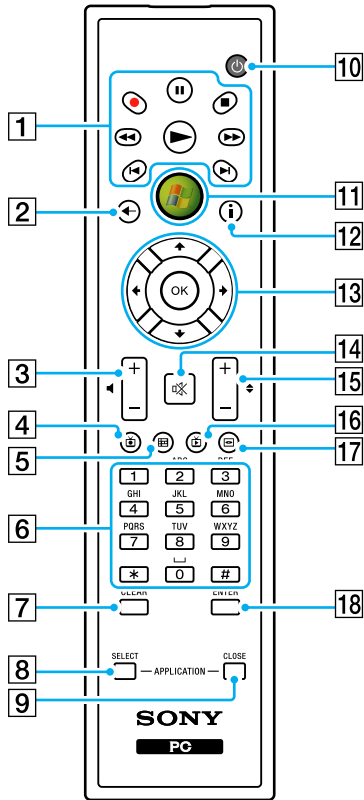

- 1** Pause **||** button
Press to pause media playback. Press again to resume playback.
Stop **■** button
Press to stop media playback or TV recording session.
Forward **▶▶** button
Press to fast-forward media at three speeds.
Skip **▶I** button
Press to move media forward, for example, one audio track, one DVD chapter, and 30 seconds of recorded TV or video.
Replay **I◀** button
Press to move media backward, for example, one audio track, one DVD chapter, and seven seconds of TV or video.
Rewind **◀◀** button
Press to move media backward at three speeds.
Record **●** button
Press to begin recording.
Play **▶** button
Press to begin media playback.
- 2** Back button
Press to return to the previous window.
- 3** Volume buttons
Press to increase (+) or decrease (-) the volume.
- 4** Recorded TV button
Press to view previously recorded TV programs (In **My TV** window).

- 5** Guide button
Press to view the TV program guide for your area.
- 6** Alphanumeric buttons
Press to select specific channels or enter text. (Press **ENTER** or **OK** to activate the channel selection.)
- 7** **CLEAR** button
Press to backspace and delete entered text.
- 8** **APPLICATION SELECT** button
Press to switch among open applications. This button works the same as the **Alt+Tab** keys.
- 9** **APPLICATION CLOSE** button
Press to close the active application window.
- 10** Standby button
Press to place the computer into Sleep mode to reduce power consumption.
- 11** Start button
Press to open the **Media Center Start** menu.
- 12** More button
Press to view additional options that are available for Media Center features.
- 13** Directional arrow buttons
Press the **↑**, **↓**, **←**, and **→** buttons to move the pointer on the screen.
OK button
Press to select the desired action or window option. When watching full-screen TV, press to return to the previous channel. Press again to switch between channels.
- 14** Muting button
Press to turn off the sound. Press again to restore the sound.
- 15** Channel/Page buttons
Press to change or page up/down channels (no number input required).
- 16** Live TV button
Press to view TV programs.
- 17** DVD menu button
Press to open the main menu on a DVD.
- 18** **ENTER** button
Press to activate feature or action, such as channel selection or return to previous channel. (This button's actions are similar to using the **OK** button.)

Controlling your TV volume with the supplied remote commander

You can change the volume on your TV with the supplied remote commander by changing the remote commander's signal setting to match with the one used by your TV manufacturer.

Press and hold the **OK** button and press alphanumeric buttons to enter the desired manufacturer code. For example, press and hold the **OK** button and press the **0** and **2** buttons consecutively to enter the manufacturer code for Sony: Sony (02).

Manufacturer	Code
VAIO computer (default setting)	01
Sony	02
Samsung	03, 05, 06, 08, 11, 13
Toshiba	07, 09
Panasonic	04, 10
Sharp	07, 12



If your TV manufacturer has more than one manufacturer code, you may not be able to control the TV volume with the remote commander even though you have specified one of them for matching the signal setting. In such a case, try another code.

Changes to this signal setting for the TV volume control may not work on some TVs. Sony assumes no liability for the controllability.

Before you use the remote commander

Before using the remote commander, you need to insert the supplied AA manganese batteries and connect the remote sensor to enable communication between the computer and the remote commander.

To insert batteries

- 1 Turn the remote commander over.
- 2 Slightly push down the dented area (1), slide the battery cover in the direction of the arrow, and remove the cover.

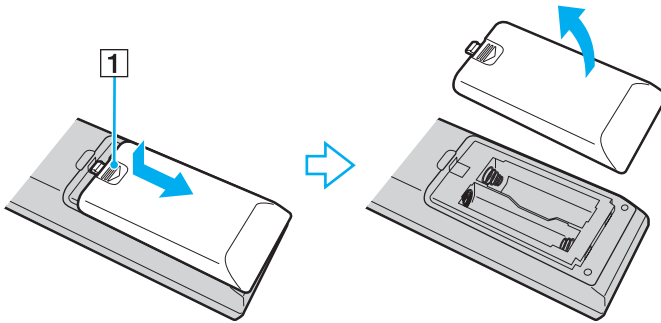

- 3 Insert the supplied two AA batteries into the remote commander.

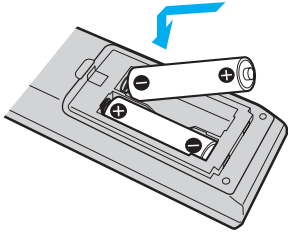

- 4 Put the battery cover back on the remote commander and slide it in the reverse direction of the arrow illustrated above until the cover clicks into place.



If the remote commander does not operate properly, you may need to replace the batteries. When the remote commander is not going to be used for an extended period of time, remove the batteries to avoid possible damage from battery leakage.

If you are using a cable or satellite set-top box, you can attach the remote sensor control to the remote sensor, which enables you to control the set-top box with the remote commander.

To connect the remote sensor control

- 1 Plug the cable from the remote sensor control (1) into the **INFRARED TRANSMITTER OUT** jack (2) on the computer.

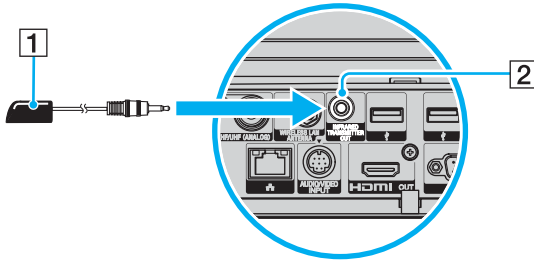

- 2 Remove the adhesive tape cover from the bottom of the remote sensor control (1).
- 3 Attach the remote sensor control (1) onto the set-top box (3) near the infrared port (4).

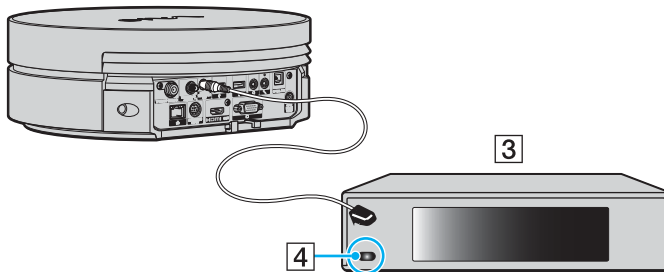

! Do not cover the infrared port when attaching the remote sensor control.

The remote sensor must be visible in a line-of-sight with the remote commander in order to function properly.

Using the Memory Stick Media

Your computer supports the Memory Stick media. Memory Stick media is a compact, portable, and versatile IC recording media especially designed for exchanging and sharing digital data with compatible products, such as digital cameras, mobile phones and other devices. Because it is removable, it can be used for external data storage.

For the latest information about the Memory Stick media, visit the Memory Stick Web site at <http://www.memorystick.com/en/>.



Your computer has been tested and found compatible with the Sony branded Memory Stick media with capacity of up to 4 GB that are available as of September 2006. However, not all Memory Stick media that meet the same conditions as the compatible media are guaranteed of compatibility.

Inserting a Memory Stick media with multiple conversion adapters is not guaranteed of compatibility.

MagicGate is the general name of the copyright protection technology developed by Sony. Use a Memory Stick media with the MagicGate logo to use this feature.



The Memory Stick PRO/Duo media slot is located behind the front panel door. You need to open this door before accessing the slot.

Inserting a Memory Stick Media

To insert a Memory Stick media

- 1 Slide open the front panel door with your fingertip.
- 2 Locate the Memory Stick PRO/Duo media slot ([page 10](#)).
- 3 Hold the Memory Stick media with the arrow facing upward and pointing toward the Memory Stick PRO/Duo media slot.
- 4 Carefully slide the Memory Stick media into the slot until it clicks into place.
The Memory Stick media is automatically detected by your system and appears in your **Computer** window as a local drive, under the appropriate drive name (depending on the configuration of the computer).

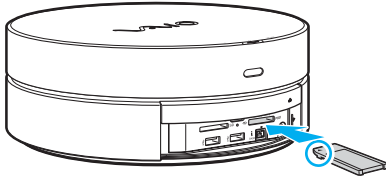

! Be sure to hold the Memory Stick media with the arrow pointing in the correct direction as you insert it into the slot. To avoid damaging your computer or the Memory Stick media, do not force the Memory Stick media into the slot if you cannot insert it smoothly.

Do not insert more than one Memory Stick media into the slot. Improper insertion of the media may damage both your computer and the media.

While the Memory Stick media is in the slot, you cannot close the front panel door. A forceful attempt to close the door may damage both your computer and the media.



Your computer supports Memory Stick Duo media and is equipped with the Memory Stick PRO/Duo slot that is compatible with both standard- and duo-size media. For more information on the Memory Stick Duo media, visit the Memory Stick Web site at <http://www.memorystick.com/en/>.

You can insert a Memory Stick Duo media directly into the slot.

To view the contents of the Memory Stick media

- 1 Click **Start** and **Computer** to open the **Computer** window.
- 2 Double-click the Memory Stick media icon to view the list of data files saved in the Memory Stick media.

To format a Memory Stick media

The Memory Stick media has been formatted in the factory default setting and is ready for use. If you want to reformat the media with your computer, follow these steps.

! Be sure to use the device that is designed to format the media and supports the Memory Stick media when formatting the media.

Formatting the Memory Stick media erases the entire data on the media. Avoid accidental erasure of your valuable data.

Do not remove the Memory Stick media from the slot while formatting the media. This could cause a malfunction.

- 1 Carefully slide the Memory Stick media into the slot until it clicks into place.
- 2 Click **Start** and **Computer** to open the **Computer** window.
- 3 Right-click the Memory Stick media icon and select **Format**.
- 4 Click **Restore device defaults**.

! The size of the allocation unit and file system may change.

Do not select **NTFS** from the **File system** drop-down list.



The formatting process will be completed more quickly if you select **Quick Format** in **Format options**.

- 5 Click **Start**.
- 6 At the confirmation prompt, click **OK**.
The formatting process starts.



It may take time to format the Memory Stick media depending on the media.

- 7 Once completed, click **OK**.
- 8 Click **Close**.

Removing a Memory Stick Media

To remove a Memory Stick media

- 1 Check that the Media Access indicator light is off.
- 2 Firmly grasp the extended part of the Memory Stick media.
- 3 Carefully pull it out of the slot.

! Always remove the Memory Stick media gently, or it may pop out unexpectedly.

Do not remove the Memory Stick media while the Media Access indicator light is turned on. If you do, you may lose data. Large volumes of data may take time to load, so be sure the indicator is off before removing the Memory Stick media.

Using Other Memory Cards

In addition to the Memory Stick PRO/Duo media slot, your computer is equipped with an **SD** memory card slot to accommodate other memory cards. You can use this slot to transfer data among digital cameras, camcorders, music players, and other audio/video devices.



The memory card slot is located behind the front panel door. You need to open this door before accessing the slot.

Before You Use Memory Cards

The **SD** memory card slot on your computer supports the following memory cards:

- MultiMediaCard (MMC)
- Secure Digital (SD)

For the latest information on compatible memory cards, visit the Sony online support Web site regularly.



Always insert the correct memory card into the **SD** memory card slot.

SD memory cards with capacity of over 2 GB, such as SD High Capacity (SDHC) memory cards, are not supported.

Do not attempt to insert a memory card or memory card adapter of a different type into the slot. An incompatible memory card or memory card adapter may be difficult to remove from the slot and can cause damage to your computer.

Use care when inserting or removing a memory card from the slot. Do not force the memory card in or out of the slot.

The **SD** memory card slot on your computer does not support the high-speed data transfer feature of the SD memory card.

Your computer has been tested and found compatible only with major memory card media available as of September 2006. However, not all memory card media that meet the same conditions as the compatible media are guaranteed of compatibility.

Inserting a Memory Card

To insert a memory card

- 1 Slide open the front panel door with your fingertip.
- 2 Locate the **SD** memory card slot ([page 10](#)).
- 3 Hold the memory card with the arrow pointing toward the memory card slot.

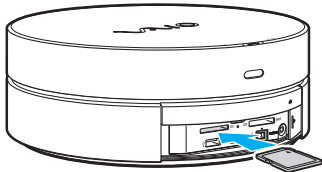

- 4 Carefully slide the memory card into the slot until it clicks into place.
Do not force the card into the slot.



If the memory card does not go into the slot easily, remove it gently and verify you are inserting it in the proper direction.



While a memory card is in the slot, you cannot close the front panel door. A forceful attempt to close the door may damage both your computer and the media.

Removing a Memory Card

! Do not remove a memory card while the Media Access indicator light is on. The card or its data may become damaged.

To remove a memory card

- 1 Check that the Media Access indicator light is off.
- 2 Firmly grasp the extended part of the memory card.
- 3 Carefully pull it out of the slot.

Using the Internet

To use the Internet, you need to connect an external modem device, for example a USB telephone modem, an xDSL modem, or a cable modem, to your computer. For the detailed instructions on connection setups and modem configuration, see the manual that came with your modem.

Using Wireless LAN (WLAN)

Using the Sony Wireless LAN (WLAN), all your digital devices with built-in WLAN functionality communicate freely with each other through a network. A WLAN is a network in which a user can connect to a local area network (LAN) through a wireless (radio) connection. So there is no need anymore to pull cables or wires through walls and ceilings.

You can communicate without an access point, which means that you can communicate between a limited number of computers (ad-hoc). Or you can communicate through an access point, which allows you to create a full infrastructure network (infrastructure).



WLAN uses the IEEE 802.11b/g standard, which specifies the used technology. The standard includes the encryption methods: Wired Equivalent Privacy (WEP), which is a security protocol, Wi-Fi Protected Access 2 (WPA2), and Wi-Fi Protected Access (WPA). Proposed jointly by the IEEE and Wi-Fi Alliance, both WPA2 and WPA are specifications of standards based, interoperable security enhancements that increase the level of data protection and access control for existing Wi-Fi networks. WPA has been designed to be forward compatible with the IEEE 802.11i specification. It utilizes the enhanced data encryption TKIP (Temporal Key Integrity Protocol) in addition to user authentication using 802.1X and EAP (Extensible Authentication Protocol). Data encryption protects the vulnerable wireless link between clients and access points. Besides that, there are other typical LAN security mechanisms to ensure privacy, such as: password protection, end-to-end encryption, virtual private networks, and authentication. WPA2, the second generation of WPA, provides stronger data protection and network access control and is also designed to secure all versions of 802.11 devices, including 802.11b, 802.11a, and 802.11g, multi-band and multi-mode. In addition, based on the ratified IEEE 802.11i standard, WPA2 provides government grade security by implementing the National Institute of Standards and Technology (NIST) FIPS 140-2 compliant AES encryption algorithm and 802.1X-based authentication. WPA2 is backward compatible with WPA.

Wireless LAN devices using the IEEE 802.11a standard and the ones using the IEEE 802.11b or g standard cannot communicate because the frequencies are different.

IEEE 802.11b: The standard speed is 11 Mbps, or about 30 to 100 times faster than a standard dial up.

IEEE 802.11a/g: The standard speed is 54 Mbps, or about 5 times faster than a wireless LAN device using the IEEE 802.11b standard.

The 2.4 GHz bandwidth used by wireless LAN compatible devices is also used by other various devices. Although technologies to minimize interference from other devices that use the same bandwidth are employed on wireless LAN compatible devices, such interference may cause lower communication speed, narrower communication range, or broken wireless connections.

The communication speed varies depending on the distance between communication devices, existence of obstacles between such devices, the device configuration, the radio conditions, and the software in use. In addition, communications may be cut off depending on the radio conditions.

The communication range varies depending on the actual distance between communication devices, existence of obstacles between such devices, the radio conditions, the ambient environment that includes existence of walls and materials of such walls, and the software in use.

Deploying IEEE 802.11b and IEEE 802.11g products on the same wireless network may reduce the communication speed due to radio interference. Taking this into consideration, the IEEE 802.11g products are designed to reduce the communication speed to ensure communications with IEEE 802.11b products.

When the communication speed is not as fast as expected, changing the wireless channel on the access point may increase the communication speed.

Connecting the Wireless LAN Antenna

To use the wireless LAN functionality on your computer, you must connect the supplied wireless LAN antenna to your computer.

To connect the wireless LAN antenna

Screw the wireless LAN antenna cable (1) counterclockwise into the **WIRELESS LAN ANTENNA** port (2) on the back of your computer.

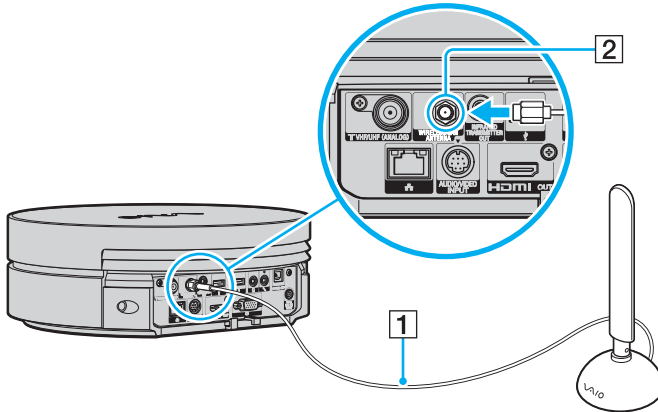

! Be sure to keep the wireless LAN antenna at least 11 inches (30 cm) away from your computer.



For better reception, if needed, you may mount the wireless LAN antenna to a wall using the supplied screw.

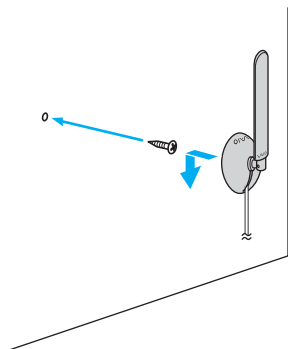

Communicating without an Access Point (Ad-hoc)

An ad-hoc network is a network in which a local network is created only by the wireless devices themselves, with no other central controller or access point. Each device communicates directly with other devices in the network. You can set up an ad-hoc network easily at home.

- ❑ If the wireless connection is initiated by the VAIO computer, channel 11 will be selected.
- ❑ If the wireless connection is initiated by peer wireless LAN equipment, the wireless LAN communication will make use of the channel selected by the peer wireless LAN equipment.

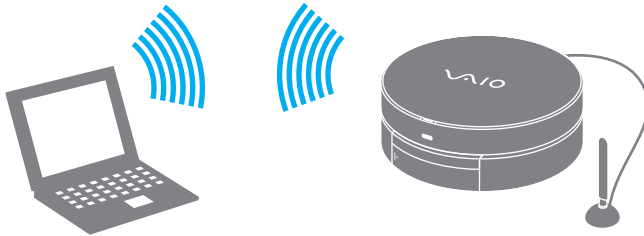

To communicate without an access point (ad-hoc)



You cannot select the 5 GHz bandwidth, which is used for the IEEE 802.11a standard, on ad-hoc networks.

- 1 Turn on the **WLAN** switch.
The Wireless LAN indicator lights up.
- 2 Click **Start** and **Control Panel**.
- 3 Click **View network status and tasks** under **Network and Internet**.
- 4 Click **Set up a connection or network** on the left pane.
The **Set up a connection or network** window appears.
- 5 Select an option to specify the ad-hoc network settings and click **Next**.
- 6 Follow the on-screen instructions.

Communicating with an Access Point (Infrastructure)

An infrastructure network is a network that extends an existing wired local network to wireless devices by providing an access point (not supplied), for example the Sony Access Point. The access point bridges the wireless and wired LAN and acts as a central controller for the wireless LAN. The access point coordinates transmission and reception from multiple wireless devices within a specific range.

The access point will select which channel to use on an infrastructure network.

! For details on how to select the channel that will be used by the access point, see the manual that came with your access point.

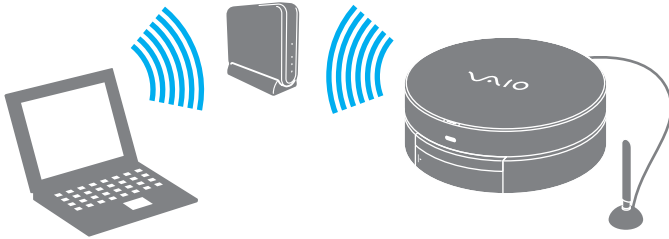

To connect to a wireless network

- 1 Make sure an access point is set up.
See the manual that came with your access point for more information.
- 2 Turn on the **WLAN** switch.
The Wireless LAN indicator lights up.
- 3 Click **Start** and **Control Panel**.
- 4 Click **View network status and tasks** under **Network and Internet**.
- 5 Click **Manage wireless networks**.
- 6 Click **Add**.
- 7 Follow the on-screen instructions.

To disconnect from a wireless network

Turn off the **WLAN** switch.



Turning off the wireless LAN functionality while accessing remote documents, files, or resources may result in data loss.



For WPA-PSK or WPA2-PSK authentication, you must enter a network key of 8 to 64 alphanumeric characters long.

Using Peripheral Devices

You can add functionality to your VAIO computer by using the various ports on the computer.

- ❑ **Selecting Display Modes** ([page 79](#))
- ❑ **Using the Multiple Monitors Function** ([page 80](#))
- ❑ **Connecting a Universal Serial Bus (USB) Device** ([page 82](#))
- ❑ **Connecting a Printer** ([page 85](#))
- ❑ **Connecting an i.LINK Device** ([page 86](#))
- ❑ **Connecting to a Network (LAN)** ([page 88](#))

Selecting Display Modes

You can select which display to be used as the primary monitor when two displays (TV, desktop monitor, etc.) are connected to your computer.

If you want to work on both displays at the same time, see **Using the Multiple Monitors Function (page 80)** for more information.

To select a display

- 1 Right-click on the desktop and select **Personalize** from the shortcut menu.
- 2 Click **Display Settings**.
The **Display Settings** window appears.
- 3 Follow the on-screen instructions to change the settings.



You may not be able to display the same contents on both displays (including a combination of one display and one projector) at the same time, depending on the type of your display or projector.

Before turning on your computer, turn on the peripheral devices.

Using the Multiple Monitors Function

The Multiple Monitors function allows you to distribute portions of your desktop across separate displays. For example, if you have a display connected to the **HDMI** port and another connected to the monitor (VGA) port, two displays can function as a single desktop.

You can move the cursor from one display to the other. This allows you to drag objects, such as an open application window or a toolbar, from one display to the other.

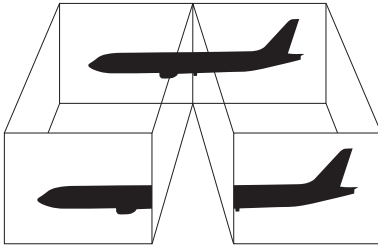

Your external display may not support the Multiple Monitors function.

Certain software applications may not be compatible with Multiple Monitors settings.

Make sure that your computer does not enter Sleep mode while you are using Multiple Monitors mode; otherwise the computer may not return to Normal mode.

If you set different colors on each display, do not expand a single window across two displays; otherwise your software may not work properly.

Set fewer colors or a lower resolution for each display.

To select the Multiple Monitors mode

- 1 Right-click on the desktop and select **Personalize** from the shortcut menu.
- 2 Click **Display Settings**.
The **Display Settings** window appears.
- 3 Follow the on-screen instructions to change the settings.



Additionally, you can set the display colors and resolution for each display and customize the Multiple Monitors mode.

Connecting a Universal Serial Bus (USB) Device



You need to slide open the front panel door to access the USB ports on the front.

Connecting a USB Mouse

To connect a USB mouse

- 1 Choose the USB port (1)  you prefer to use.
- 2 Plug the USB mouse cable (2) into the USB port.
- 3 You can now use your USB mouse (not supplied) (3).

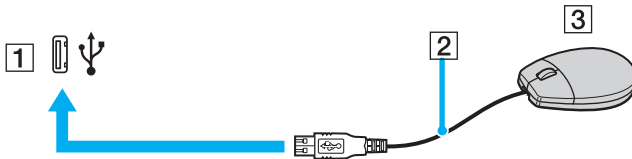

Connecting a USB Floppy Disk Drive

You can purchase a USB floppy disk drive and connect it to your computer.

To connect a USB floppy disk drive

- 1 Choose the USB port (1)  you prefer to use.
- 2 Plug the USB floppy disk drive cable (2) into the USB port.
Your USB floppy disk drive (3) is now ready for use.

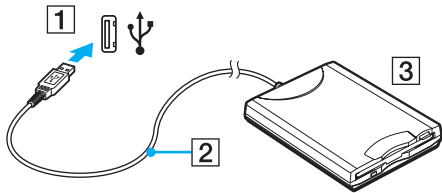

! When using a USB floppy disk drive, do not apply force on the USB port. This may cause a malfunction.

Disconnecting a USB floppy disk drive

You can disconnect a USB floppy disk drive when your computer is on or off. Disconnecting the drive when the computer is in Sleep mode may cause the computer to malfunction.

If the computer is off, you can unplug the USB cable directly from the computer.

To disconnect a USB floppy disk drive

- 1 Close all programs accessing the floppy disk drive.
- 2 Double-click the **Safely Remove Hardware** icon on the taskbar.
The **Safely Remove Hardware** window appears.
- 3 Select the floppy disk drive you want to unplug.
- 4 Click **Stop**.
The **Stop a Hardware device** window appears.
- 5 Confirm that the floppy disk drive can be safely removed from the system.
- 6 Click **OK**.
A message appears stating it is now safe to remove the hardware device.
- 7 Click **OK**.
- 8 Click **Close** to close the **Safely Remove Hardware** window.
- 9 Disconnect the floppy disk drive from the computer.

Connecting a Printer

You can connect a Windows-compatible printer to your computer to print documents.

Connecting a Printer Using the USB Port

You can connect a USB printer compatible with your version of Windows to the computer.



You need to slide open the front panel door to access the USB ports on the front.

To connect a printer using the USB port

- 1 Plug the power cord (1) of your printer into an AC outlet.
- 2 Choose the USB port (3)  you prefer to use.
- 3 Plug one end of a USB printer cable (2) (not supplied) into the USB port and the other end to your printer.

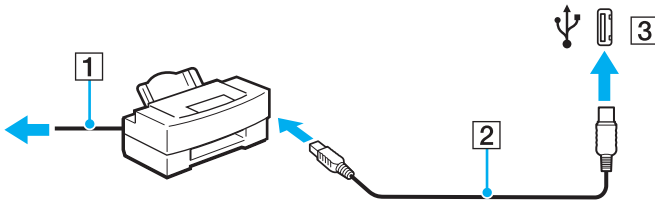

Connecting an i.LINK Device

Notes on connecting i.LINK devices

- ❑ Your computer is equipped with an i.LINK port, which you can use to connect to an i.LINK device such as a digital video camcorder.
- ❑ The i.LINK port on your computer does not supply power to external devices generally powered by i.LINK ports.
- ❑ The i.LINK port supports transfer rates up to 400 Mbps; however, the actual transfer rate depends on the transfer rate of the external device.
- ❑ The optional i.LINK cables may not be available, depending on the country or area of your residency.
- ❑ An i.LINK connection with other compatible devices is not fully guaranteed.
- ❑ The i.LINK connection varies depending on the software applications, operating system, and i.LINK-compatible devices you use. See the manual that came with your software for more information.
- ❑ Check the working conditions and OS compatibility of i.LINK-compatible PC peripherals (for example, an HDD or a CD-RW drive) before you connect them to your computer.

Connecting a Digital Video Camcorder



The i.LINK port is located behind the front panel door. You need to open this door before accessing the port.

To connect a digital video camcorder

- 1 Plug one end of an i.LINK cable (1) (not supplied) into the i.LINK port (2) on the computer and the other end into the DV In/Out port (3) on the digital video camcorder.
- 2 Launch the **DVgate Plus** software.

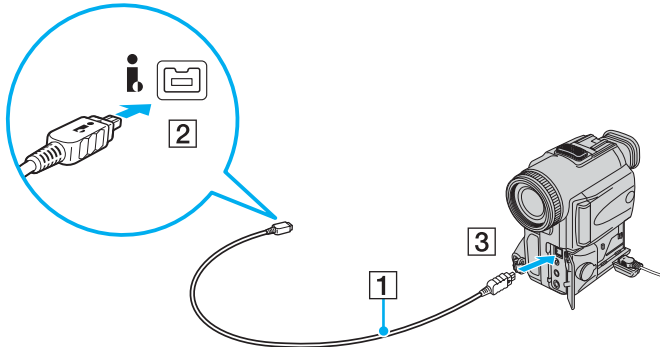

On Sony digital video cameras, ports labeled **DV Out**, **DV In/Out**, or **i.LINK** are i.LINK-compatible.

The Sony digital video camcorder shown here is an example; your digital video camcorder may need to be connected differently.

You cannot access the pictures stored on a Memory Stick media when using an i.LINK connection.

Connecting to a Network (LAN)

You can connect your computer to 100BASE-TX/10BASE-T-type networks with an Ethernet network cable. Connect one end of a network cable (not supplied) to the network (Ethernet) port on the left of the computer and the other end to your network. For detailed settings and devices needed to connect to the network, ask your network administrator.

!

Your computer has a protective sticker  covering the network (Ethernet) port located on its back. Connect a 10BASE-T or 100BASE-TX cable to the network (Ethernet) port. Using an incorrect cable, such as a phone cable, may result in an electric current overload that can cause a malfunction, excessive heat, or fire in the network (Ethernet) port. For help on connecting to a network, ask your network administrator.

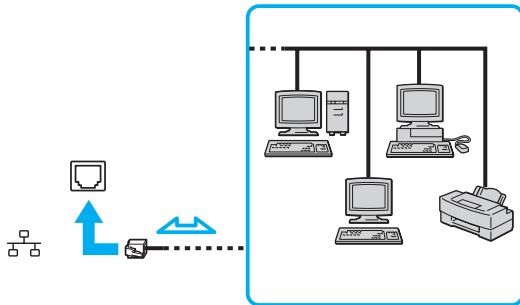

Your computer can be connected to the network with the default settings.

! Telephone lines cannot be connected to the network (LAN) connector on your computer. If the network (LAN) connector is connected to the telephone lines mentioned below, high electric current to the connector may cause damage, overheating, or fire.

- Home (intercom speakerphone) or business-use telephone lines (multi-line business telephone)
- Public telephone subscriber line
- PBX (private branch exchange)

Do not plug a telephone cable into the network port.

Customizing Your VAIO Computer

This section briefly describes how to change the main settings of your VAIO computer. Among other things, you will learn how to use and customize the look of your Sony software and utilities, etc.

- ❑ **Setting the Password** ([page 91](#))
- ❑ **Setting Up Your Computer with VAIO Central** ([page 94](#))
- ❑ **Using the Power Saving Modes** ([page 95](#))

Setting the Password

Use one of the BIOS functions to set the password.

Once you have set the password, you will have to enter the password after the VAIO logo appears to start your computer. The power-on password will allow you to protect the computer from unauthorized access.

Adding the Power-on Password

The power-on password is provided to protect your computer from unauthorized access.

There are two types of the power-on password: machine password and user password. The machine password is provided for users with administrator rights on the computer to change all the setup options on the BIOS setup screen, as well as to start the computer. The user password is provided for other standard users to allow for changing some of the BIOS setup options, as well as starting the computer. To set the user password, you must first set the machine password.

! Once you have set the power-on password, you cannot start your computer without entering the password. Make sure not to forget the password. Write down your password and keep it safe and private from other people.

If you forget the power-on password and need assistance to reset it, a password reset fee will be charged, and your computer may need to be sent in for depot service for password reset.

To add the power-on password

- 1 Turn on the computer.
- 2 Press the **F2** key when the VAIO logo appears.
The BIOS setup screen appears. If not, restart the computer and press the **F2** key several times when the VAIO logo appears.
- 3 Press the **←** or **→** key to select **Security** to display the **Security** tab, select **Set Machine Password**, and then press the **Enter** key.
- 4 On the password entry screen, enter the password twice and press the **Enter** key.
The password can be up to 32 alphanumeric characters (including spaces) long.
- 5 At the confirmation prompt, press the **Enter** key.



The following is to configure your computer to prompt password entry when you turn it on or display the BIOS setup screen.

- 6 Select **Password when Power On** under **Security**.
Press the space bar to change the setting from **Disabled** to **Enabled**.
- 7 Press the **←** or **→** key to select **Exit**, select **Exit Setup**, and then press the **Enter** key.
At the confirmation prompt, press the **Enter** key.

Changing/Removing the Power-on Password

To change or remove the power-on password

- 1 Turn on the computer.
- 2 Press the **F2** key when the VAIO logo appears.
The BIOS setup screen appears. If not, restart the computer and press the **F2** key several times when the VAIO logo appears.
- 3 Enter the current password for **Enter Password** and press the **Enter** key.
- 4 Press the **←** or **→** key to select **Security** to display the **Security** tab, select **Set Machine Password**, and then press the **Enter** key.
- 5 On the password entry screen, enter the current password once and a new password twice, and then press the **Enter** key.
To remove the password, leave the **Enter New Password** and **Confirm New Password** fields blank and press the **Enter** key.
When confirmation to save the changes is prompted, press the **Enter** key.
- 6 Press the **←** or **→** key to select **Exit**, select **Exit Setup**, and then press the **Enter** key.
At the confirmation prompt, press the **Enter** key.

Setting Up Your Computer with VAIO Central

The **VAIO Central** utility allows you to consult system information and specify preferences for system behavior.

To use VAIO Central

- 1 Click **Start, All Programs**, and **VAIO Central**.
The **VAIO Central** window appears.
- 2 Click the **System Information** tab.
- 3 Select the desired control item and change the settings.
- 4 Once finished, click **OK**.
The setting of the desired item has been changed.



Some of the control items will not be visible if you open **VAIO Central** as a standard user.

Using the Power Saving Modes

In addition to the normal operating mode, which allows you to turn off specific devices, your computer has a distinct power saving mode called Sleep mode.

Using Normal Mode

This is the normal state of the computer when it is in use. To save power while not working, you can turn off a specific device such as the connected display or the hard disk.

Using Sleep Mode

Sleep mode temporarily suspends the entire system operations for lower power consumption. The orange power light is on in this mode.

To activate Sleep mode

Click **Start**, the arrow next to the **Lock** button, and **Sleep**.



Alternatively, you can slide the power switch on the wireless keyboard to **OFF** position, or press the standby button on the keyboard or the remote commander to place your computer into Sleep mode.

To return to Normal mode

- Press the power button on your computer.
- Slide the power switch on the wireless keyboard to the **ON** position; or press the standby button or the space bar on the wireless keyboard.
- Press the standby button on the wireless keyboard or the remote commander.



If you press and hold the power button for more than four seconds, your computer will turn off automatically. You will lose any unsaved data.

If the computer is not used for more than 20 minutes, it will enter Sleep mode. To avoid this, you can change the Sleep mode settings.

To change the Sleep mode settings

- 1 Right-click the power status icon on the taskbar and select **Power Options**.
- 2 Click **Change plan settings** under the current power plan.
- 3 Change the time to put the computer to sleep and click **Save Changes**.

Upgrading Your VAIO Computer

Your VAIO computer and memory modules use high precision components and electronic connectors technology. To avoid invalidation of the warranty during your product warranty period, we recommend that:

- You contact your dealer to install a new component.
- You do not install it yourself, if you are not familiar with upgrading a computer.
- You do not touch the connectors on any component.

For the type of components available for upgrading and the amount of memory installed on your model, see the online **Specifications**.

For assistance, contact an authorized Sony Service Center. To find the nearest center or agent, see **Sony Support Information** ([page 140](#)) or visit the Sony online support Web site.

Adding and Removing Memory

If you want to expand the functionality of your computer, you can increase the memory by installing optional memory modules. Before you upgrade your computer's memory, read the notes and procedures in this section. The number of available slots depends on your computer's hardware configuration.

Notes on adding/removing memory modules

- ❑ Be careful when changing memory. Improper installation of memory modules may cause damage to your system. This damage may void your manufacturer's warranty.
- ❑ Only use memory modules that are compatible with your computer. If a memory module is not detected by the computer or the Windows operating system becomes unstable, contact your sales dealer or the manufacturer of your memory module.
- ❑ Electrostatic discharge (ESD) can damage electronic components. Before touching a memory module, ensure the following:
 - ❑ The procedures described in this document assume familiarity with the general terminology associated with personal computers and with the safety practices and regulatory compliance required for using and modifying electronic equipment.
 - ❑ Turn off your computer and disconnect it from its power source (that is, AC adapter) and from any telecommunication links, networks, or modems before you remove any cover or panel from the computer. Failure to do so may result in personal injury or equipment damage.
 - ❑ ESD can damage memory modules and other components. Install the memory module only at an ESD workstation. If such a station is not available, do not work in a carpeted area, and do not handle materials that produce or hold static electricity (cellophane wrappers, for example). Ground yourself by maintaining contact with an unpainted metal portion of the chassis while performing the procedure.
 - ❑ Do not open the memory module package before you are ready to change the module. The package protects the module from ESD.

- ❑ Use the special bag delivered with the memory module or wrap the module in aluminum foil to protect it from ESD.
- ❑ Introducing any liquids, foreign substances, or objects into the memory module slots or other internal components of your computer will result in damage to the computer and any repair costs will not be covered by the warranty.
- ❑ Do not place the memory module in a location subject to:
 - ❑ Heat sources such as radiators or air ducts
 - ❑ Direct sunlight
 - ❑ Excessive dust
 - ❑ Mechanical vibration or shock
 - ❑ Strong magnets or speakers that are not magnetically shielded
 - ❑ Ambient temperature of more than 95°F (35°C) or less than 41°F (5°C)
 - ❑ High humidity
- ❑ Handle the memory module with care. To avoid injuries to your hands and fingers, do not touch the edges of the components and circuit boards inside your computer.

Removing and Installing a Memory Module

To change or add a memory module

- 1 Shut down the computer and disconnect all peripheral devices.
- 2 Unplug the computer and wait until the computer cools down.
- 3 Unscrew the screws (indicated by the arrows below) on the bottom of the computer and remove the memory module compartment cover.

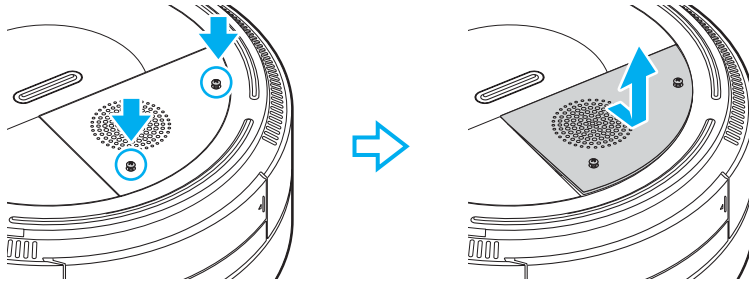

! When placing your computer upside down, be sure to put the computer on a soft cloth to protect it from scratches.

- 4 Touch a metal object (such as the connector panel on the back of the computer) to discharge static electricity.

5 Remove the currently installed memory module:

- ❑ Pull the latches in the direction of the arrows (1).
The memory module is released.
- ❑ Make sure that the memory module tilts up and then pull it out in the direction of the arrow (2).

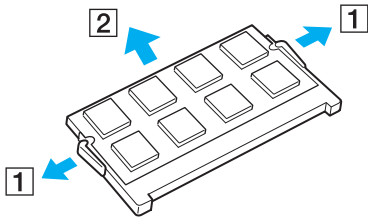

6 Remove the new memory module from its packaging.

- 7 Slide the memory module into the memory module slot and push it in until it clicks into place.

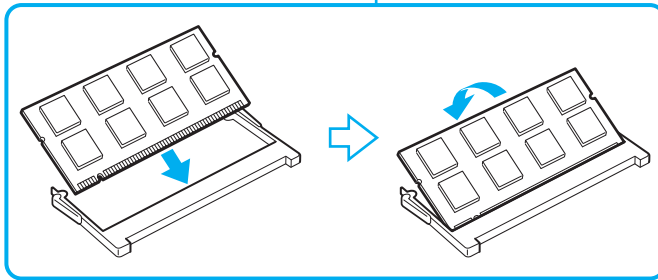
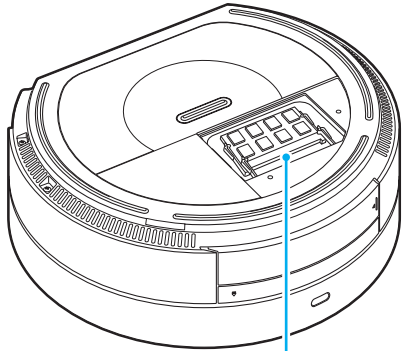

! Do not touch any other components on the motherboard.

Be sure to insert the connector edge of the memory module into the slot while aligning the notch on the module with the small projection in the open slot.

- 8 Replace the memory module compartment cover and tighten the screws on the bottom of the computer.

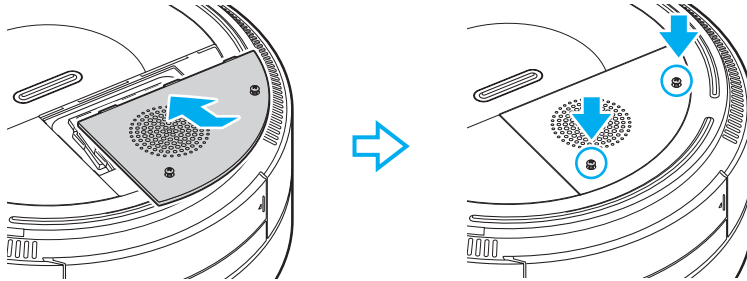

- 9 Connect a power source and turn on the computer.

Viewing the Amount of Memory

To view the amount of memory

- 1 Turn on the computer.
- 2 Click **Start**, **All Programs**, and **VAIO Central**.
The **VAIO Central** window appears.
- 3 Click the **System Information** tab.
- 4 Double-click the **System Information** folder.
- 5 Double-click the **System Information** icon.
You can view the amount of system memory. If the additional memory does not appear, repeat the whole installation procedure and restart the computer.

Precautions

This section describes safety guidelines and precautions to help you protect your VAIO computer from potential damage.

- ❑ **On Using the Power Source** ([page 106](#))
- ❑ **On Handling Your Computer** ([page 107](#))
- ❑ **On Handling Floppy Disks** ([page 110](#))
- ❑ **On Handling Discs** ([page 111](#))
- ❑ **On Using Headphones** ([page 111](#))
- ❑ **On Handling Memory Stick Media** ([page 112](#))
- ❑ **On Handling the Hard Disk** ([page 113](#))

On Using the Power Source

- ❑ See the online **Specifications** to check the power operation of your model.
- ❑ Do not share the AC outlet with other power-consuming equipment, such as a photocopier or shredder.
- ❑ You can purchase a power strip with a surge protector. This device prevents damage to your computer caused by sudden power surges, in an electrical storm, for example.
- ❑ Do not place heavy objects on the power cord.
- ❑ To disconnect the cord, pull it out by the plug. Never pull the cord itself.
- ❑ Unplug your computer from the AC outlet if you are not planning to use the computer for a long period of time.
- ❑ Make sure that the AC outlet is easily accessible.
- ❑ Use the AC adapter supplied with your computer or genuine Sony products. Do not use any other AC adapter as it may cause a malfunction.
- ❑ Use the power cord supplied with your computer or genuine Sony products. Do not use any other power cord as it may cause a malfunction.

On Handling Your Computer

- ❑ Clean the cabinet with a soft cloth, which is dry or lightly moistened with a mild detergent solution. Do not use any type of abrasive pad, scouring powder, or solvent such as alcohol or benzene, as these may damage the finish of your computer.
- ❑ If you drop a solid object or any liquid onto your computer, shut down the computer and then unplug it. You may want to have the computer checked by qualified personnel before operating it again.
- ❑ Do not drop your computer.
- ❑ Do not place your computer in a location subject to:
 - ❑ Heat sources, such as radiators or air ducts
 - ❑ Direct sunlight
 - ❑ Excessive dust
 - ❑ Moisture or rain
 - ❑ Mechanical vibration or shock
 - ❑ Strong magnets or speakers that are not magnetically shielded
 - ❑ Ambient temperature of more than 95°F (35°C) or less than 41°F (5°C)
 - ❑ High humidity
- ❑ Do not place electronic equipment near your computer. The electromagnetic field of the computer may cause a malfunction.
- ❑ Do not place any objects on top of your computer as it may cause:
 - ❑ Degradation in performance of the computer
 - ❑ Discolorations on the surface of the computer
 - ❑ Physical injuries if an object falls; or falls off the computer and breaks

- ❑ Be sure to place your computer in the flat position as it is not designed for upright placement.
- ❑ Provide adequate air circulation to prevent internal heat from building up. The internal heat will cause your computer to malfunction.
 - ❑ Do not place your computer on porous surfaces such as rugs or blankets, or near material such as curtains or draperies that may block its air vents.
 - ❑ Be sure to allow clearance of at least 2 inches (5 cm) wide on either side (1) of your computer.
 - ❑ Keep the front (2) and back (3) of your computer unblocked.

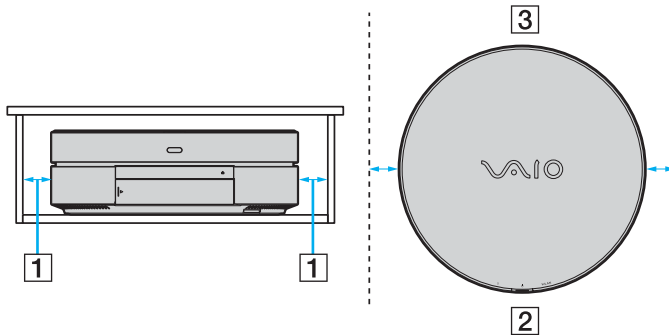

- ❑ When holding your computer, be sure to wait until it cools down. The back of your computer may be extremely hot around the air exhaust vent.
- ❑ Your computer uses high-frequency radio signals and may cause interference to radio or TV reception. If this occurs, relocate the computer a suitable distance away from the set.
- ❑ Use only specified peripheral equipment and interface cables; otherwise, problems may occur.
- ❑ Do not use cut or damaged connection cables.

- ❑ If your computer is brought directly from a cold location to a warm one, moisture may condense inside the computer. In this case, allow at least one hour before turning on the computer. If any problems occur, unplug the computer and contact an authorized Sony Service Center. To find the nearest center or agent, see **Sony Support Information (page 140)** or visit the Sony online support Web site.
- ❑ Make sure you disconnect the power cord before cleaning your computer.
- ❑ To avoid losing data if your computer is damaged, back up your data regularly.

On Handling Floppy Disks

- ❑ Do not open the shutter manually or touch the surface of the floppy disk.
- ❑ Keep floppy disks away from magnets.
- ❑ Keep floppy disks away from direct sunlight and other sources of heat.
- ❑ Keep floppy disks away from any liquid. Do not let them get wet. When you are not using your floppy disk, always remove it from the floppy disk drive and use a storage case.
- ❑ If the floppy disk comes with an adhesive label, make sure that the label is properly affixed. If the edge of the label is curled up, the label may stick to the inside of the floppy disk drive and cause a malfunction or damage your floppy disk.

On Handling Discs

- ❑ Do not touch the surface of the disc.
- ❑ Do not drop or bend the disc.
- ❑ Fingerprints and dust on the surface of a disc may cause read errors. Always hold the disc by its edges and central hole, as shown below:

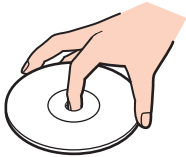

- ❑ Proper care of the disc is essential to its continuous reliability. Do not use solvents (such as benzene, thinner, alcohol, commercially available cleaners, or anti-static spray) which may cause damage to the disc.
- ❑ For normal cleaning, hold the disc by its edge and use a soft cloth to wipe the surface from the center out.
- ❑ If the disc is badly soiled, moisten a soft cloth with water, wring it out well, and use it to wipe the surface of the disc from the center out. Wipe off any remaining moisture with a dry soft cloth.
- ❑ Never affix an adhesive label to a disc. This will affect the use of the disc irreparably.

On Using Headphones

Preventing hearing damage – Avoid using headphones at high volume. Hearing experts advise against continuous, loud and extended play. If you experience a ringing in your ears, reduce the volume or discontinue use.

On Handling Memory Stick Media

- Do not use the media in a location subject to static electricity or electrical noise.
- Do not touch the Memory Stick media connector with your finger or metallic objects.
- Use only the adhesive label supplied with the Memory Stick media as a label.
- Do not bend, drop, or apply strong shock to the Memory Stick media.
- Do not disassemble or modify Memory Stick media.
- Do not let Memory Stick media get wet.
- Do not use or store Memory Stick media in a location subject to:
 - Extremely high temperatures, such as in a car parked in the sun
 - Direct sunlight
 - High humidity
 - Corrosive substances
- Use the storage case supplied with the Memory Stick media.
- Be sure to make a backup copy of your valuable data.
- Keep the Memory Stick media out of reach of children. There is a risk of swallowing the media.
- When using the Memory Stick Duo media, do not use a fine-tipped pen to write on the label adhered to the Memory Stick Duo media. Exerting pressure on the media may damage internal components.

On Handling the Hard Disk

The hard disk has a high storage density and reads or writes data in a short time. However, it can be easily damaged by mechanical vibration, shock, or dust.

Although the hard disk has the internal safety device to prevent losing data due to mechanical vibration, shock or dust, you should be careful when handling your computer.

To avoid damaging your hard disk

- Do not subject your computer to sudden movements.
- Keep your computer away from magnets.
- Do not place your computer in a location subject to mechanical vibration or in an unstable position.
- Do not move your computer while the power is on.
- Do not turn off the power or restart your computer while reading or writing data to the hard disk.
- Do not use your computer in a place subject to extreme changes in temperature.



If the hard disk is damaged, the data cannot be restored.

Troubleshooting

This section describes how to solve common problems you might encounter when using your VAIO computer. Many problems have simple solutions. Try these suggestions before visiting the Sony online support Web site at:

<http://esupport.sony.com/EN/VAIO/> for customers in USA,

<http://www.sony.ca/support> for customers in Canada,

<http://esupport.sony.com/ES/VAIO/> for customers in Spanish speaking Latin American countries or areas, or

<http://esupport.sony.com/ES/VAIO/BR/> for customers in Brazil.

- ❑ **Computer** ([page 115](#))
- ❑ **System Security** ([page 121](#))
- ❑ **Networking** ([page 122](#))
- ❑ **Optical Discs** ([page 125](#))
- ❑ **Display** ([page 129](#))
- ❑ **Printing** ([page 131](#))
- ❑ **Microphone** ([page 132](#))
- ❑ **Speakers** ([page 133](#))
- ❑ **Keyboard** ([page 134](#))
- ❑ **Touch Pad** ([page 135](#))
- ❑ **Floppy Disks** ([page 136](#))
- ❑ **Audio/Video** ([page 137](#))
- ❑ **Memory Stick Media** ([page 138](#))
- ❑ **Peripherals** ([page 139](#))

Computer

What should I do if my computer does not start?

- ❑ Make sure your computer is securely plugged into a power source and turned on. Make sure the power indicator shows the power is on.
- ❑ Make sure the floppy disk drive (if applicable) is empty.
- ❑ If your computer is plugged into a power strip or an uninterruptible power supply (UPS), make sure the power strip or UPS is plugged into a power source and turned on.
- ❑ Make sure your external display is plugged into an appropriate power source and turned on.
- ❑ Make sure the brightness and contrast controls on your external display are adjusted correctly.
- ❑ Disconnect the AC adapter. Wait three to five minutes. Reattach the AC adapter and press the power button to turn on your computer.
- ❑ Condensation may cause your computer to malfunction. If this occurs, do not use the computer for at least one hour.
- ❑ Remove any extra memory modules you may have installed since purchase.
- ❑ Make sure your computer is not in Sleep mode by pressing the power button on the computer or the standby button on the wireless keyboard or the remote commander.

What should I do if a BIOS error appears when I turn on my computer?

If the message "Press <F1> to resume, <F2> to setup" appears at the bottom of the screen, follow these steps:

- 1 Press the **F2** key.
The BIOS setup screen appears. If not, restart the computer and press the **F2** key several times when the VAIO logo appears.
- 2 Set the date (month/day/year). Press the **Enter** key.
- 3 Press the **↓** key to select **System Time**, and then set the time (hour: minute: second). Press the **Enter** key.
- 4 Press the **→** key to select the **Exit** tab, and then press the **F9** key.
At the confirmation prompt, press the **Enter** key.
- 5 Select **Exit Setup**, and press the **Enter** key.
At the confirmation prompt, press the **Enter** key.
Your computer restarts.

If this occurs frequently, contact an authorized Sony Service Center. To find the nearest center or agent, see **Sony Support Information** ([page 140](#)) or visit the Sony online support Web site.

What should I do if the power indicator lights but my screen stays blank?

- ❑ Make sure the proper input for your display (TV, VGA, DVI-D monitor) is selected.
- ❑ Make sure your display (TV, VGA, DVI-D monitor) is turned on.
- ❑ If your display is still blank, follow these steps:
 - 1 Press the power button on your computer for more than four seconds to check that the power indicator goes out. Then turn on your computer again.
 - 2 If your display still stays blank, unplug the power cord and leave the computer for about a minute. Then plug in the power cord and turn on the computer again.

! Turning off your computer with the power button may cause loss of unsaved data.

What should I do if my computer or software stops responding?

- ❑ If your computer stops responding while a software application is running, press the **Alt+F4** keys to close the application window.
- ❑ If the **Alt+F4** keys do not work, click **Start**, the arrow next to the **Lock** button, and **Shut Down** to turn off your computer.
- ❑ If your computer does not turn off, press the **Ctrl+Alt+Delete** keys and click the arrow  next to the **Shut down** button and **Shut Down**.
If the **Windows Security** window appears, click **Shut Down**.



Turning off your computer with the **Ctrl+Alt+Delete** keys or the power button may cause loss of unsaved data.

- ❑ If your computer still does not turn off, press and hold the power button until the computer turns off.
- ❑ Remove the power cord.
- ❑ Try reinstalling the software.
- ❑ Contact the software publisher or designated provider for technical support.

Why doesn't my computer enter Sleep mode?

Your computer may become unstable if the operating mode is changed before the computer completely enters Sleep mode.

To restore your computer to normal operating stability

- 1 Close all open programs.
- 2 Click **Start**, the arrow next to the **Lock** button, and **Restart**.
- 3 If your computer does not restart, press the **Ctrl+Alt+Delete** keys and click the arrow next to the **Shut down** button and **Restart**.
- 4 If this procedure does not work, press and hold the power button until the computer turns off.

! Turning off your computer with the power button may cause loss of unsaved data.

What should I do if Windows does not start, showing a message, when I start my computer?

- Make sure your computer does not have a "non-bootable" disc in the optical disc drive.
- If a non-bootable disc is in the drive, follow these steps:
 - 1 Remove the disc.
 - 2 Restart your computer and confirm that the Windows operating system launches properly.
- If you enter a wrong power-on password three times consecutively, the **Enter Onetime Password** message appears and Windows will not start. Press and hold the power button for more than four seconds to check that the VAIO power indicator goes off. Wait for 10 or 15 seconds, then restart your computer and enter the correct password. When entering the password, check that the Num Lock indicator and Caps Lock indicator on the wireless keyboard are off. If any are lit, press the **Num Lock** key or the **Caps Lock** key to turn off the indicator before entering the password.

What should I do if my game software does not work or it keeps crashing?

- ❑ Check the Web site of the game if there are any patches or updates to download.
- ❑ Make sure you have installed the latest video driver.
- ❑ On some VAIO models, the graphics memory is shared with the system. The optimal graphic performance in this case is not guaranteed.

What should I do if I cannot remember the BIOS password?

If you have forgotten the BIOS password, contact an authorized Sony Service Center to reset it. A reset fee will be charged. To find the nearest center or agent, see **Sony Support Information (page 140)** or visit the Sony online support Web site.

Why does it take time before my computer starts?

If Norton Internet Security's Personal Firewall is active, it may take some time before the desktop screen appears due to network security checkups.

Why doesn't my screen turn off when the time selected for the automatic turn-off action has passed?

The **VAIO Original Screen Saver** disables the timer setting, which you can select using the Windows power options, for your screen to turn off.

Select the screen saver other than the **VAIO Original Screen Saver**.

System Security

This section provides information about keeping your computer operating smoothly and protecting against potential threats to the computer's security.

How can I protect my computer against security threats, such as viruses?

The Microsoft Windows operating system is preinstalled on your computer. The best way to protect your computer against security threats, such as viruses, is to download and install the latest Windows updates regularly.

You can get important Windows updates by doing the following:

! Your computer must be connected to the Internet before you can receive updates.

- 1 Connect to the Internet.
- 2 Double-click the **Windows Security Alerts** icon on the taskbar.
- 3 Follow the on-screen instructions to set up automatic or scheduled updates.

How do I keep my antivirus software updated?

You can keep the **Norton Internet Security** software program current with the latest updates from Symantec Corporation.

To download and install the latest security update

- 1 Click **Start, All Programs, Norton Internet Security**, and **Norton Internet Security**.
- 2 Click the item to update the software on the left pane.
- 3 Follow the on-screen instructions to select and download updates.

Networking

What should I do if my computer cannot connect to a wireless LAN access point?

- Connection availability is affected by distance and obstructions. You may need to move your computer away from obstructions or closer to any access point you may be using.
- Make sure the **WLAN** switch is on and the Wireless LAN indicator is lit on your computer.
- Make sure power to the access point is on.
- Follow these steps to check the settings:
 - 1 Click **Start** and **Control Panel**.
 - 2 Click **View network status and tasks** under **Network and Internet**.
 - 3 Click **Connect to a network** to confirm that your access point is selected.
- Make sure the encryption key is correct.

What should I do if I cannot access the Internet?

- Check the access point settings. See the manual that came with your access point for more information.
- Make sure your computer and the access point are connected to one another.
- Move your computer away from obstructions or closer to any access point you may be using.
- Make sure your computer is properly configured for Internet access.

Why is the data transfer speed slow?

- ❑ The wireless LAN data transfer speed is affected by distance and obstructions between devices and access points. Other factors include device configurations, radio conditions, and software compatibility. To maximize the data transfer speed, move your computer away from obstructions or closer to any access point you may be using.
- ❑ If you are using a wireless LAN access point, the device may be temporarily overloaded depending on how many other devices are communicating via the access point.
- ❑ If your access point interferes with other access points, change the access point channel. See the manual that came with your access point for more information.

How do I avoid data transfer interruptions?

- ❑ When your computer is connected to an access point, data transfer interruptions may occur when using large files or if the computer is in close proximity to microwaves and cordless telephones.
- ❑ Move your computer closer to the access point.
- ❑ Make sure the access point connection is intact.
- ❑ Change the access point channel. See the manual that came with your access point for more information.

What are channels?

- ❑ Wireless LAN communication occurs on divided frequency bands known as channels. Third-party wireless LAN access point channels may be preset to different channels from Sony devices.
- ❑ If you are using a wireless LAN access point, see connectivity information contained in the manual that came with your access point.

Why does the network connection stop when I change the encryption key?

Two computers with the wireless LAN functionality may lose a peer-to-peer network connection if the encryption key is changed. You can either change the encryption key back to the original profile or re-enter the key on both computers so the key matches.

Optical Discs

Why does my computer freeze when I try to read a disc?

The disc that your computer is trying to read may be dirty or damaged. Follow these steps:

- 1 Press the **Ctrl+Alt+Delete** keys and click the arrow next to the **Shut down** button and **Restart** to restart the computer.
- 2 Remove the disc from the optical disc drive.
- 3 Check the disc for dirt or damage. If you need to clean the disc, see **On Handling Discs (page 111)** for instructions.

What should I do if the drive tray does not open?

- Make sure your computer is on.
- Push in the optical disc drive tray.
- If this does not work, click **Start** and **Computer**. Right-click the optical disc drive icon, and select **Eject** from the shortcut menu.
- If none of the above options work, insert a thin, straight object (such as a paper clip) in the manual eject hole on the optical disc drive.
- Try restarting your computer.

What should I do if I cannot play a disc properly on my computer?

- ❑ Make sure the disc is inserted into the optical disc drive with the label facing upward.
- ❑ Make sure the necessary program(s) is installed according to the manufacturer's instructions.
- ❑ If a disc is dirty or damaged, your computer will stop responding. Follow these steps:
 - 1 Press the **Ctrl+Alt+Delete** keys and click the arrow next to the **Shut down** button and **Restart** to restart the computer.
 - 2 Remove the disc from the optical disc drive.
 - 3 Check the disc for dirt or damage. If you need to clean the disc, see **On Handling Discs (page 111)** for instructions.
- ❑ If you are playing a disc and cannot hear sound, do any of the following:
 - ❑ Check if the volume is turned off or minimized by the muting or volume button, respectively, on the remote commander.
 - ❑ Right-click the volume icon on the taskbar and click **Open Volume Mixer** to check the settings.
 - ❑ Check the volume setting in the audio mixer.
 - ❑ If you are using external speakers, check the volume settings on the speakers and the connections between the speakers and your computer.
 - ❑ Make sure the correct driver software is installed. Follow these steps:
 - 1 Click **Start** and **Control Panel**.
 - 2 Click **System and Maintenance**.
 - 3 Click **System**.
 - 4 Click **Device Manager** on the left pane.

The **Device Manager** window appears with a listing of your computer's hardware devices.
If an "X" or an exclamation point appears on the listed device, you may need to enable the device or reinstall the drivers.
 - 5 Double-click the optical disc drive device to open a list of the optical disc drives of your computer.

6 Double-click the desired drive.

You can confirm the driver software by selecting the **Driver** tab, and clicking **Driver Details**.

7 Click **OK** to close the window.

- Make sure an adhesive label is not affixed to a disc. Adhesive labels can come off while the disc is in the optical disc drive and damage the drive or cause it to malfunction.
- If a region code warning appears, the disc may be incompatible with the optical disc drive. Check the DVD package to make sure the region code is compatible with the optical disc drive.
- If you notice condensation on your computer, do not use the computer for at least one hour. Condensation can cause the computer to malfunction.

What should I do if I cannot write data to CD media?

- ❑ Make sure you neither launch any software application nor allow any to launch automatically, not even a screen saver.
- ❑ Stop using the keyboard.
- ❑ If you are using a CD-R/RW disc with an adhesive label affixed, replace it with one with no affixed adhesive label. Using a disc with an affixed adhesive label could cause a write error or other damage.

What should I do if I cannot write data to DVD media?

- ❑ Make sure you are using the correct DVD recordable media.
- ❑ Check which DVD recordable format is compatible with your optical disc drive. Note the possibility that some brands of DVD recordable media do not work.
- ❑ The preinstalled software on your computer does not support copying DVD movies. Macrovision or a similar video protection technology prevents users from copying DVD movies. Copying a DVD movie would be a copyright infringement and therefore illegal.

Display

What should I do if my TV screen stays blank?

- Make sure that both power cords of your computer and TV are securely plugged into power sources.
- Make sure that your computer and TV are properly connected.
- Make sure that both your computer and TV are turned on.
- When two displays are connected to your computer, make sure that the display settings are correct on the other display. See **Selecting Display Modes** (page 79).

What should I do if my TV screen is dark?

- Adjust the brightness control on your TV to brighten the screen. See the manual that came with your TV for the detailed instructions.
- Check other inputs on your TV for brightness. If they also appear dark, see the manual that came with your TV for adjustment.

What should I do if my TV shows distorted images?

Make sure that your computer and TV are properly connected.

What should I do if the screen of my TV that is connected to the HDMI OUT port stays blank?

- ❑ Unplug the HDMI cable once and plug it back.
- ❑ Your TV may not be HDCP compliant. Be sure to use an HDCP compliant TV.
- ❑ When two displays are connected to your computer, make sure that the display settings are correct on the other display. See **Selecting Display Modes** (page 79).

What should I do if my TV does not show a clear view of the Windows desktop?

Depending on your TV, it may not be capable of displaying the Windows desktop as clearly as computer displays. You may solve this problem by disabling the image quality settings on your TV, such as noise reduction, correction features, and enhancer features; but it also depends on your TV if such changes to the settings are available. For more information, see the manual that came with your TV.

How do I run Windows Aero?

This Q & A entry applies to selected models only.

To run Windows Aero, follow these steps:

- 1 Click **Start** and **Control Panel**.
- 2 Click **Customize colors** under **Appearance and Personalization**.
- 3 Click **Open classic appearance properties for more color options**.
The **Appearance Settings** window appears.
- 4 Select **Windows Aero** from the **Color scheme** options on the **Appearance** tab.
- 5 Click **OK**.

Printing

What should I do if I cannot print a document?

- ❑ Make sure your printer is on, and the printer cable is securely connected to the ports on the printer and computer.
- ❑ Make sure your printer is compatible with the Windows operating system installed on your computer.
- ❑ You may need to install the printer driver software before you use your printer. See the manual that came with your printer for more information.
- ❑ If your printer is not functioning after your computer resumes from Sleep mode, then restart the computer.
- ❑ If the bidirectional communication functions are provided with your printer, disabling the functions on your computer may enable printing. Follow these steps:
 - 1 Click **Start** and **Control Panel**.
 - 2 Click **Printer** under **Hardware and Sound**.
 - 3 Right-click the printer icon and select **Properties**.
 - 4 Click the **Ports** tab.
 - 5 Click to cancel the **Enable bidirectional support** check box.
 - 6 Click **OK**.

This change to the settings disables the bidirectional communication functions of the printer, such as data transfer, status monitoring, and remote panel.

Microphone

What should I do if my microphone does not work?

If you are using an external microphone, make sure the microphone is turned on and is properly plugged into the microphone jack on your computer.

- If you are using an external microphone, make sure the microphone is turned on and is properly plugged into the microphone jack on your computer.
- The muting button on the remote commander may have been pressed. Press the button once again.
- The volume may have been turned off with one of the volume control buttons on the remote commander. Press the other to turn up the volume loud enough to hear sound.

Speakers

What should I do if I do not hear sound from my speakers?

- If you are using a program that has its own volume control, make sure the volume control is properly set. See the program's help file for more information.
- Make sure the speaker volume is turned up loud enough and the audio option is enabled.
- The muting button on the remote commander may have been pressed. Press the button once again.
- The volume may have been turned off with one of the volume control buttons on the remote commander. Press the other to turn up the volume loud enough to hear sound.
- Check the Windows volume controls by clicking the volume icon on the taskbar.

What should I do if I do not hear 5.1ch audio from my speakers?

Follow these steps to check the speaker setup.

- 1 Click **Start** and **Control Panel**.
- 2 Click **Hardware and Sound**.
- 3 Click **Manage audio devices** under **Sound**.
- 4 On the **Playback** tab, select **Speakers** and click **Configure**.
The **Speaker Setup** window appears.
- 5 Select **5.1 Surround** under **Audio channels** and click **Next**.
- 6 Select the check boxes for your speakers under **Optional speakers** and click **Next**.
- 7 Select the check boxes under **Full-range speakers** and click **Next**.
- 8 Click **Finish**.

Keyboard

What should I do if the keyboard configuration is wrong?

The language layout of your wireless keyboard is labeled on the packaging box. If you choose a different regional keyboard when you complete the Windows setup, the key configuration will be mismatched.

To change the keyboard configuration, follow these steps:

- 1 Click **Start** and **Control Panel**
- 2 Click **Clock, Language, and Region**, and click **Regional and Language Options**.
- 3 Change the settings as desired.

What should I do if I cannot enter certain characters with the keyboard?

- If you cannot enter **U, I, O, P, J, K, L, M**, and so on, the **Num Lk** key may be activated. Check that the Num lock indicator is off. If the Num lock indicator is on, press the **Num Lk** key to turn it off before entering these characters.
- Avoid using any wireless devices that exchange radio signals on the 2.4 GHz frequency band near the wireless keyboard. These devices may cause interference, causing the keyboard to stop working properly.
- Do not place metal furniture near your computer or wireless keyboard, as this may create interference, causing the keyboard to stop working properly.

What should I do if my computer does not recognize my keyboard?

- Make sure the power switch on the wireless keyboard is in the **ON** position.
- Make sure the supplied AA batteries are properly installed.
- Press the **CONNECT** button on your computer and then on the wireless keyboard to re-establish the connection between the two devices.

Touch Pad

What should I do if the touch pad does not work?

- ❑ Make sure that a mouse is not connected to your computer.
- ❑ If the pointer does not move while a software application is running, press the **Alt+F4** keys to close the application window.
- ❑ If the **Alt+F4** keys do not work, click **Start**, the arrow next to the **Lock** button, and **Restart** to restart your computer.
- ❑ If your computer does not restart, press the **Ctrl+Alt+Delete** keys and click the arrow next to the **Shut down** button and **Restart**.
If the **Windows Security** window appears, click **Restart**.
- ❑ If this procedure does not work, press and hold the power button until the computer turns off.

! Turning off your computer with the power button may cause loss of unsaved data.

Floppy Disks

Why doesn't the Safely Remove Hardware icon appear on the taskbar when the drive is connected?

Your computer does not recognize the floppy disk drive. First, make sure the USB cable is properly connected to the USB port. If you need to secure the connection, wait a few moments for the computer to recognize the drive. If the icon still does not appear, follow these steps:

- 1 Close all programs that are accessing the floppy disk drive.
- 2 Wait for the LED indicator on the floppy disk drive to turn off.
- 3 Push the eject button to remove the disk, and disconnect the USB floppy disk drive from your computer.
- 4 Reconnect the floppy disk drive by inserting the USB connector (with the USB icon facing upward) into the USB port.
- 5 Restart the computer by clicking **Start**, the arrow next to the **Lock** button, and **Restart**.

What should I do if I cannot write data to a floppy disk?

- Make sure the floppy disk is properly inserted in the drive.
- If the disk is inserted properly and you are still unable to write data to it, the disk may be full or write-protected. You can either use a floppy disk that is not write-protected or disable the write-protect feature.

Audio/Video

What should I do if I cannot use my DV camcorder?

If the message appears to indicate DV equipment seems to be disconnected or turned off, the i.LINK cable may not be securely plugged into the ports on your computer or camcorder. Unplug the connectors, and plug them in again. See **Connecting an i.LINK Device (page 86)** for more information.



i.LINK is a trademark of Sony used only to designate that a product contains an IEEE 1394 connection. The procedure to establish an i.LINK connection may vary, depending on a software application, an operating system, and a compatible i.LINK device. Not all products with an i.LINK connection can communicate with each other. See the manual that came with your compatible i.LINK device for more information on operating conditions and proper connection. Before connecting compatible i.LINK PC peripherals to your system, such as a CD-RW or hard disk drive, confirm their operating system compatibility and required operating conditions.

How do I turn off the Windows startup sound?

To turn off the Windows startup sound, follow these steps:

- 1 Click **Start** and **Control Panel**.
- 2 Click **Hardware and Sound**.
- 3 Click **Manage audio devices** under **Sound**.
- 4 On the **Sounds** tab, click to cancel the **Play Windows Startup sound** check box.
- 5 Click **OK**.

Memory Stick Media

What should I do if I cannot use Memory Stick media, which were formatted on a VAIO computer, on other devices?

You may need to reformat your Memory Stick media.

Formatting Memory Stick media erases all data, including music data previously saved on it. Before you reformat Memory Stick media, back up important data and confirm that the media does not contain files you want to keep.

- 1 Copy the data from the Memory Stick media onto your computer's hard disk to save data or images.
- 2 Format the Memory Stick media by following the steps in **To format a Memory Stick media (page 63)**.

Why can't I save music files onto my Memory Stick media?

Copyright protected music cannot be checked out to any Memory Stick media other than those with the MagicGate logo.

! Use of recorded music requires permission from the copyright holders.

Sony is not responsible for music files that cannot be recorded from a CD or downloaded from other sources.

Can I copy images from a digital camera using Memory Stick media?

Yes, and you can view video clips that you have recorded with Memory Stick media-compatible digital cameras.

Why can't I write data to Memory Stick media?

Some versions of Memory Stick media are equipped with an erasure prevention switch to protect data from accidental erasure or overwriting. Make sure the erasure prevention switch is off.

Peripherals

What should I do if I cannot connect a USB device?

- ❑ If applicable, check the USB device is turned on and using its own power supply. For example, if you are using a digital camera, check if the battery is charged. If you are using a printer, check if the power cable is connected properly to the AC outlet.
- ❑ Try using another USB port on your computer. The driver could be installed to the specific port you used the first time you connected the device.
- ❑ See the manual that came with your USB device for more information. You may need to install software before you connect the device.
- ❑ Try connecting a simple, low-powered device such as a mouse to test if the port is working at all.
- ❑ USB hubs may prevent a device from working because of the distribution of power. We recommend you connect the device directly to your computer without a hub.

Support Options

This section contains information on where to go for answers to questions about your VAIO computer and the preinstalled software.

Sony Support Information

See the following sources for answers in the sequence listed below.

1 VAIO Computer Documentation

This on-screen **User Guide** (this manual) and the printed **Welcome mat** provide information on how to maximize your computer's capabilities and solve common problems.

2 Program Guides and Help Files

The preinstalled programs on your computer may be supplied with individual help guides. These guides are stored on the hard disk as on-screen help files. You can find the help files from the help menu under the specific program.

3 Operating System Online Support

Your computer comes preinstalled with a Microsoft Windows operating system. For operating system support, you can visit Microsoft customer support at: <http://support.microsoft.com/directory/>.

4 Sony Computing Support

This service provides instant access to information on commonly encountered problems. Type a description of the problem and the Knowledge Database searches for the corresponding solutions online.

You can visit the Sony online support Web site at:

<http://esupport.sony.com/EN/VAIO/> for customers in USA,

<http://www.sony.ca/support> for customers in Canada,

<http://esupport.sony.com/ES/VAIO/> for customers in Spanish speaking Latin American countries or areas, or

<http://esupport.sony.com/ES/VAIO/BR/> for customers in Brazil.

5 VAIO Update

When your computer is connected to the Internet, **VAIO Update** automatically notifies you when critical software and security information is posted on the support Web site. Click the **VAIO Update** notice to open the VAIO Support Web site and view the information.

Program Support Information

Depending on the computer model and particular configuration you purchased, your computer may not include all of the software programs listed below.

Contacts for Sony software products are listed below:

- ❑ For users in USA
Web site <http://esupport.sony.com/EN/VAIO/>
Telephone 888-4-SONY-PC (888-476-6972)
- ❑ For users in Canada
Web site <http://www.sony.ca/support>
Telephone 888-4-SONY-PC (888-476-6972)
- ❑ For users in Spanish speaking Latin American countries or areas
Web site <http://esupport.sony.com/ES/VAIO/>
- ❑ For users in Brazil
Web site <http://esupport.sony.com/ES/VAIO/BR/>

For contacts about third-party software products, see the following.

Adobe® Photoshop® Elements, Premiere®, Reader®

Adobe Systems Inc.

- ❑ For users in USA and Canada
Web site <http://www.adobe.com/support>
Telephone 800-685-3652

America Online® (Dial-Up)

America Online, Inc.

- For users in USA and Canada
Web site <http://www.aol.com>

AOL® Music Now

America Online, Inc.

- For users in USA and Canada
Web site <http://www.premiumservices.aol.com>

AOL® Explorer

America Online, Inc.

- For users in USA and Canada
Web site <http://www.aol.com>

AOL® Toolbar

America Online, Inc.

- For users in USA and Canada
Web site <http://help.aol.com/help>

AOL® Instant Messenger™

America Online, Inc.

- For users in USA and Canada
Web site <http://www.aim.com>

Ask Search Assistant

IAC Search & Media, Inc.

For contacts about the software, see **Program Support Information (page 142)**.

Ask Toolbar

IAC Search & Media, Inc.

For contacts about the software, see **Program Support Information (page 142)**.

Bluetooth® Utility

TOSHIBA Corporation

For contacts about the software, see **Program Support Information (page 142)**.

Cingular Connection Manager

Cingular Wireless

For contacts about the software, see **Program Support Information (page 142)**.

Click to DVD® software

Sony Electronics Inc.

At the touch of a button, Click to DVD software allows you to automatically burn DVDs from a digital video (DV) device. Create DVDs by capturing video content straight from a DV device or by importing video from stored files — and you can also edit the video. Create DVD photo albums and slide shows with picture files or by importing pictures from a digital still camera. What's more, you can give a professional look to your DVDs by adding chapter menus, backgrounds, and menu screens. You are only a few clicks away from your own DVDs!

For contacts about the software, see **Program Support Information (page 142)**.

DVgate Plus™ software

Sony Electronics Inc.

Connect a compatible digital video camera to your computer's i.LINK port and capture video clips and still images. Edit clips from your video, add new clips, and combine clips into new movie segments. Save your movies back to your digital video camera or in a variety of popular file formats.

For contacts about the software, see **Program Support Information (page 142)**.

InstantOn

InterVideo, Inc.

- For users in USA and Canada
Web site <http://www.intervideo.com/jsp/Support.jsp>

Microsoft® Office Basic Edition, Office Professional Edition, Office Small Business Edition

Microsoft Corp.

- For users in USA and Canada
Web site <http://support.microsoft.com>

60-Day Trial Version of Microsoft® Office

! The Microsoft Office 60-Day Trial software included with this computer system is intended for evaluation purposes only. The software has been installed and you must activate the software before you can use it. Product activation procedures will be detailed during initial launch of the software; activation requires Internet access. This software has an expiration date of 60 days from the date of first use, at which time the software will operate under reduced-functionality mode, limiting end-user options and operations.

Microsoft Corp.

- For users in USA and Canada
Web site <http://support.microsoft.com>

Microsoft® Internet Explorer, Movie Maker, Media Player, Works

Microsoft Corp.

- For users in USA and Canada
Web site <http://support.microsoft.com>

MobiTV®

MobiTV, Inc.

- For users in USA and Canada
Web site <http://www.mobitv.com/support/support.php>

Netscape® Browser

America Online, Inc.

- For users in USA and Canada
Web site <http://browser.netscape.com>

Norton Internet Security™

Symantec Corporation

- For users in USA and Canada
Web site <http://www.symantec.com/techsupp>

PenPlus for VAIO® PC

Sony Electronics Inc.

PenPlus for VAIO PC will allow you to write or draw directly on the screen with the stylus or create "sticky note" reminders. For contacts about the software, see **Program Support Information (page 142)**.

Protector Suite QL

Sony Electronics Inc.

Protector Suite QL Edition allows you to easily setup your fingerprint sensor that comes with your computer. Protector Suite QL supports fingerprint logon, fast user switching, file encryption, registering forms and more.

For contacts about the software, see **Program Support Information (page 142)**.

Quickbooks Free Starter Edition

Intuit Inc.

- For users in USA and Canada
Web site <http://www.intuit.com/support/quicken/>

Roxio® Easy Media Creator® 9 Suite

Sonic Solutions

- For users in USA and Canada
Web site <http://support.sonic.com/>

SmartWi™ Connection Utility

Sony Electronics Inc.

SmartWi Connection Utility allows you to easily switch between the various wireless components (Wireless LAN, Wireless WAN, and Bluetooth® technology connectivity) that came with your computer.

For contacts about the software, see **Program Support Information (page 142)**.

SonicStage® software

Sony Electronics Inc.

The SonicStage jukebox software program gives you all the tools you need to manage music on your computer. SonicStage software supports high-quality digital audio storage, a sleek player skin design, and audio CD burning capability.

For contacts about the software, see **Program Support Information (page 142)**.

SonicStage Mastering Studio™ software

Sony Electronics Inc.

Use SonicStage Mastering Studio software to record songs from analog records or cassette tapes into your computer and output them to CDs, DVDs, or audio files in WAV format.

For contacts about the software, see **Program Support Information (page 142)**.

System Mechanic® 6

iolo technologies®, LLC

- For users in USA and Canada

Web site <http://www.iolo.com/contactus.cfm>

Trend Micro™ Anti-Spyware

Trend Micro, Inc.

- For users in USA and Canada

Web site <http://kb.trendmicro.com/search/default.asp>

Ulead BD DiscRecorder for VAIO® computers

Ulead Systems, Inc.

For questions and technical assistance, please check the help and the readme files.

VAIO® Action Setup

Sony Electronics Inc.

VAIO Action Setup manages the settings for your computer's shortcut keys.

For contacts about the software, see **Program Support Information** ([page 142](#)).

VAIO® Camera Capture Utility

Sony Electronics Inc.

VAIO Camera Capture Utility is provided for capturing still images and movies with the external camera connected to a USB port or an i.LINK® port on your computer or with the built-in MOTION EYE® camera on your computer.

For contacts about the software, see **Program Support Information** ([page 142](#)).

VAIO® Camera Utility

Sony Electronics Inc.

VAIO Camera Utility provides you with various video quality settings when using the internal camera.

For contacts about the software, see **Program Support Information** ([page 142](#)).

VAIO® Central

Sony Electronics Inc.

VAIO Central provides a central location that gathers resources to configure your VAIO computer and view your computer's configuration and specifications.

For contacts about the software, see **Program Support Information** ([page 142](#)).

VAIO® Diagnostic

Sony Electronics Inc.

For contacts about the software, see **Program Support Information** ([page 142](#)).

VAIO® Edit Component

Sony Electronics Inc.

VAIO Edit Component provides enhanced editing functionality when using Adobe Premiere Pro or Adobe Premiere Elements on your VAIO computer.

For contacts about the software, see **Program Support Information** ([page 142](#)).

VAIO® HDD Protection

Sony Electronics Inc.

VAIO HDD Protection allows you to customize your settings for protecting your hard disk against shock hazards.

For contacts about the software, see **Program Support Information** ([page 142](#)).

VAIO Media™ software

Sony Electronics Inc.

VAIO Media™ software brings multimedia to your network, enabling you to share music, video, and still image files between your VAIO® computers. You can set up one or more VAIO computers as "media servers," which store your multimedia files and make them available to other compatible VAIO computers on your wired or wireless network. For contacts about the software, see **Program Support Information (page 142)**.

VAIO® Security Center

Sony Electronics Inc.

Sony cares about your VAIO personal computer. The VAIO Security Center highlights some of the security features your machine includes. For contacts about the software, see **Program Support Information (page 142)**.

VAIO® Touch Launcher

Sony Electronics Inc.

VAIO Touch Launcher allows you to run an application program or change the sound/display settings with the buttons on the launcher window. For contacts about the software, see **Program Support Information (page 142)**.

VAIO® Update

Sony Electronics Inc.

The VAIO Update utility helps you keep your VAIO® computer up to date by regularly checking the Sony online support Web site for important software updates and information for your specific VAIO computer model.

For contacts about the software, see **Program Support Information (page 142)**.

WinDVD® software for VAIO® computers

InterVideo, Inc.

- ❑ For users in USA and Canada
Web site <http://www.intervideo.com/jsp/Support.jsp>
Telephone 510-651-0888

Xdrive™

America Online, Inc.

- ❑ For users in USA and Canada
Web site <http://www.xdrive.com/support>

Zoom Utility

Sony Electronics Inc.

The Zoom Utility will allow you to magnify a portion of the screen.

For contacts about the software, see **Program Support Information (page 142)**.

